

X-Rite® SP68™
Sphere Spectrophotometer

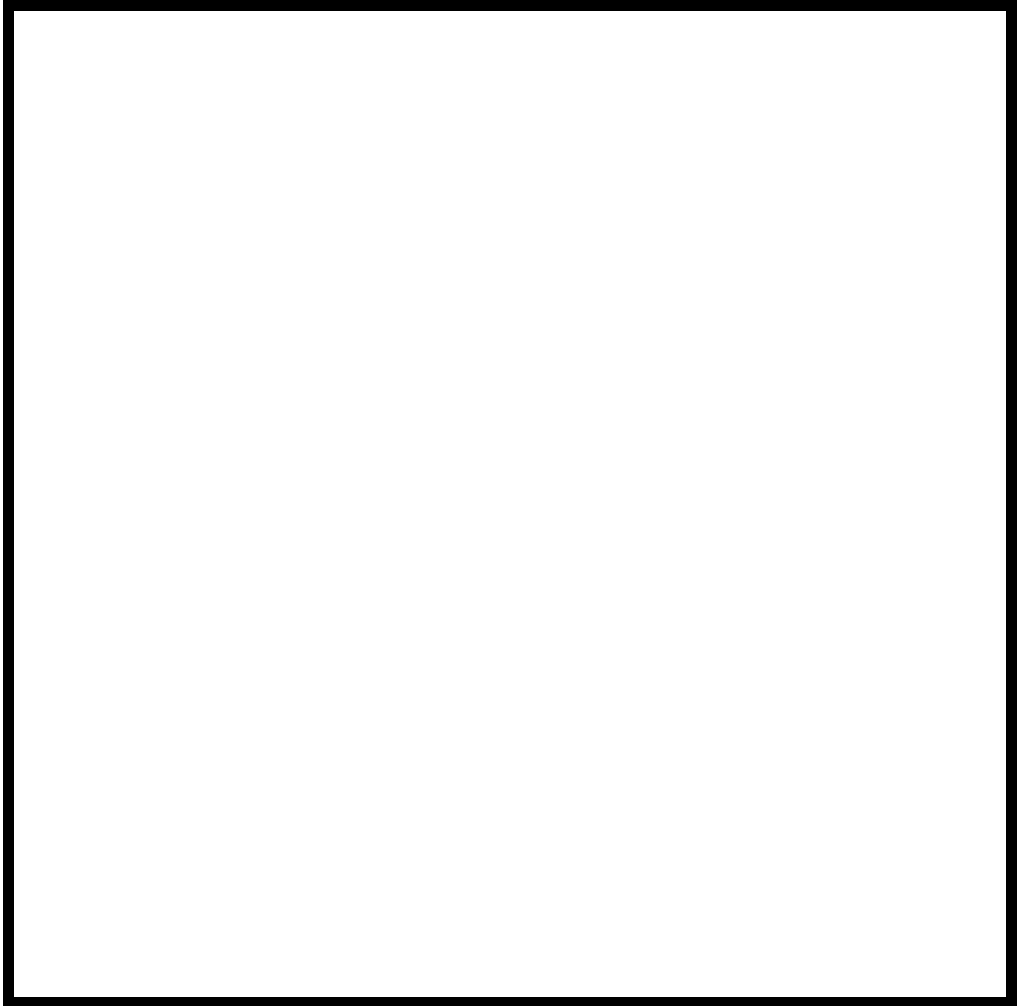

User's Manual

NOTE: Shielded interface cables must be used in order to maintain compliance with the desired FCC and European emission requirements.

WARNING: This instrument is not for use in explosive environment.

WARNUNG: Das Gerät soll in einer explosiven Umgebung NICHT verwendet werden.

ADVERTENCIA - NO use este aparato en los ambientes explosivos.

ATTENTION: Cet instrument NE DOIT PAS être utilisé dans un environnement explosif.

AVVERTIMENTO - NON usare questo apparecchio in ambienti esplosivi.

CAUTION: Operational hazard exists if battery charger other than X-Rite SE30-61 (115V) or SE30-62 (230V) is used. Use only X-Rite battery pack MA58-05, other types may burst causing personal injury.

VORSICHT: Es besteht Betriebsgefahr bei der Verwendung von einem Adapter außer X-Rite SE30-61 (115 U) oder SE30-62 (230 U). Verwenden Sie nur den X-Rite Akkupack MA58-05, mit anderen Akkus läuft die Gefahr von Explosion und Verletzung.

ADVERTENCIA: No use otro cargador de las pilas que no sea la pieza X-Rite SE30-61 (115V) o SE30-62 (230V), por el riesgo de mal funcionamiento del equipo. Use solamente las pilas MA58-05 de X-Rite, es posible que los otros tipos puedan estallar y causar daños corporales.

ATTENTION: Ne pas utiliser un autre adaptateur que la pièce X-Rite SE30-61 (115V) ou SE30-62 (230V). Utiliser seulement le pack de batteries MA58-05, il y a danger d'explosion et des blessures avec des autres types.

AVVERTENZA: Non usare un altro caricabatterie che non è del pezzo X-Rite X-Rite SE30-61 (115V) o SE30-62 (230V), per il rischio di malfunzionamento dell'apparecchio. Usare solamente gli accumulatori MA58-05 di X-Rite, è possibile che altri tipi possano scoppiare e causare danno personale.

CAUTION: Do not place battery pack in pocket. Dispose of batteries properly.

VORSICHT: Der Akkupack soll nicht auf Ihrer Person getragen werden. Beseitigen Sie ihn richtig.

ADVERTENCIA: No ponga las pilas en el bolsillo. Disponga de las pilas propiamente.

ATTENTION: Ne pas porter le pack de batteries dans la poche. S'en débarrasser correctement.

AVVERTENZA: Non mettere gli pacchi d'accumulatori in tasca. Disporre degli accumulatori propiamente.

FCC

This equipment has been tested and found to comply with the limits for a Class A digital device, pursuant to Part 15 of the FCC Rules. These limits are designed to provide reasonable protection against harmful interference when the equipment is operated in a commercial environment. This equipment generates, uses, and can radiate radio frequency energy and, if not installed and used in accordance with the instruction manual, may cause harmful interference to radio communications. Operation of this equipment in a residential area is likely to cause harmful interference in which case the user will be required to correct the interference at his own expense.

Canada

This Class A digital apparatus meets all requirements of the Canadian Interference-Causing Equipment Regulations.

Cet appareil numérique de la classe A respecte toutes les exigences du Règlement sur le matériel brouilleur du Canada.

Dear Customer:

Congratulations! We at X-Rite, Incorporated are proud to present you with an X-Rite SP68 Sphere Spectrophotometer. This instrument represents the very latest in microcontrollers, integrated circuits, fiber optics, and display technologies. As a result, your X-Rite SP68 is a rugged and reliable instrument whose performance and design exhibit the qualities of a finely engineered instrument, which is not surpassed.

To fully appreciate and protect your investment, we suggest that you take the necessary time to read and fully understand this manual. As always, X-Rite stands behind your unit with a one year limited warranty, and a dedicated service organization. If the need arises, please don't hesitate to call us.

Thank you for your trust and confidence.

X-Rite, Incorporated

Proprietary Notice

The information contained in this manual is derived from patent and proprietary data of X-Rite, Incorporated. This manual has been prepared expressly for the purpose of assisting in the use and general maintenance of this instrument.

Publication of this information does not imply any rights to reproduce or use this manual for purposes other than installing, operating, or maintaining this instrument. No part of this manual may be reproduced, transcribed, transmitted, stored in a retrieval system, or translated into any language or computer language, in any form or by any means, electronic, magnetic, mechanical, optical, manual, or otherwise, without the prior written permission of an officer of X-Rite, Incorporated.

These provisions are intended to state all of the rights and responsibilities between X-Rite, Incorporated and the customer. They supersede all warranties, expressed or implied, and whether of merchantability, fitness or otherwise. The remedies contained in this manual are exclusive. Customer and X-Rite, Incorporated waive all other remedies, including but not limited to consequential damages.

This product is covered by one or more of the following U.S. Patents:

5,400,138

Other patents pending. Foreign patent numbers provided on request.

**Copyright © 1992 by X-Rite, Incorporated
“ALL RIGHTS RESERVED”**

Limited Warranty

X-Rite, Incorporated warrants each unit manufactured to be free of defects in material and workmanship (excluding battery pack) for a period of twelve months. If the fault has been caused by misuse or abnormal conditions of operation, repairs will be billed at a nominal cost. In this case, an estimate will be submitted before work is started, if requested. The unit shall be returned with transportation charges prepaid.

THERE ARE NO WARRANTIES OF MERCHANTABILITY OR FITNESS. THIS WARRANTY OBLIGATION IS LIMITED TO SERVICING THE UNIT RETURNED TO X-RITE, INCORPORATED or AN AUTHORIZED SERVICE DEALER FOR THAT PURPOSE.

X-Rite, Incorporated offers a rate repair program for instruments out of warranty. For more information, contact X-Rite Instrument Services Department.

Always include serial number in any correspondence concerning the unit. The serial number is located on the bottom of the instrument.

This agreement shall be interpreted in accordance with the laws of the State of Michigan and jurisdiction and venue shall lie with the courts of Michigan as selected by X-Rite, Incorporated.

CAUTION: This instrument is not for use in explosive environments.

Table of Contents

General Description	vi
User Interface	vii
What To Do First!	viii
1. Getting Started	1-1
1.1 Unpacking and Inspection	1-1
1.2 Unlocking and Locking the Shoe	1-3
1.3 Installing Battery Pack	1-4
1.4 Applying Power	1-5
1.5 Charging the Battery Pack	1-6
1.6 Menu Page Selection	1-8
1.7 Display Description	1-9
2. Instrument Positioning and Measurement Techniques	2-1
3. Calibration	3-1
3.1 Positioning the Instrument on the White Calibration Standard	3-2
3.2 Positioning the Instrument on the Black Trap	3-4
3.3 Calibration Procedure	3-5
4. Normal Operation	4-1
4.1 Color Space Selection	4-1
4.2 Illuminant/Observer Selection	4-2
4.3 Reference Entry	4-3
4.4 Sample Measurement	4-5
4.5 Using Measurement Averaging	4-7
5. Pass/Fail Operation	5-1
5.1 Adjusting Tolerance Values	5-1
5.2 Pass/Fail Measurement	5-7
6. Storage Operation	6-1
6.1 Storing Measurements	6-1
6.2 Deleting Stored Measurement	6-4
6.3 Printing Stored Measurements	6-7
6.4 Tagging and Storing Operation (with optional BCR)	6-10
6.5 QA-Master "Run Job" Operation	6-15

7. Setting System Configuration	7-1
7.1 Setting RS-232 Communication Options	7-1
7.2 Setting Operation Options	7-4
7.3 Setting Printout Options	7-9
7.4 Setting Date and Time	7-12
8. General Maintenance	8-1
8.1 Cleaning the Instrument	8-1
8.2 Cleaning the Optics	8-2
8.3 Replacing the Battery Pack	8-3
8.4 Replacing the Target Window	8-4
8.5 Lamp Replacement Information	8-5
8.6 Troubleshooting Tips	8-6
9. Bar Code Reader (Optional)	9-1
9.1 Attaching the SP78-200 BCR to the Instrument	9-1
9.2 Scanning a Bar Code	9-2
9.3 Troubleshooting	9-3
Appendices	
A - Technical Specifications	A-1
B - Display Messages	B-1
C - Optional Accessories	C-1
D - Color Check	D-1

General Description

The X-Rite SP68 is a portable sphere spectrophotometer designed to give fast, precise, and accurate color measurement information on any surface - smooth to textured on a number of different materials - including paper, paint, plastic, and textiles.

The SP68 uses a dual beam optics system which ensures long-term stability, accuracy, and reliability of measurements. The pulsed tungsten lamp provides a reliable and consistent light source which has a very long life and prevents heat build-up.

To determine the influence of the specular component, the SP68 automatically provides both specular-included and specular-excluded data.

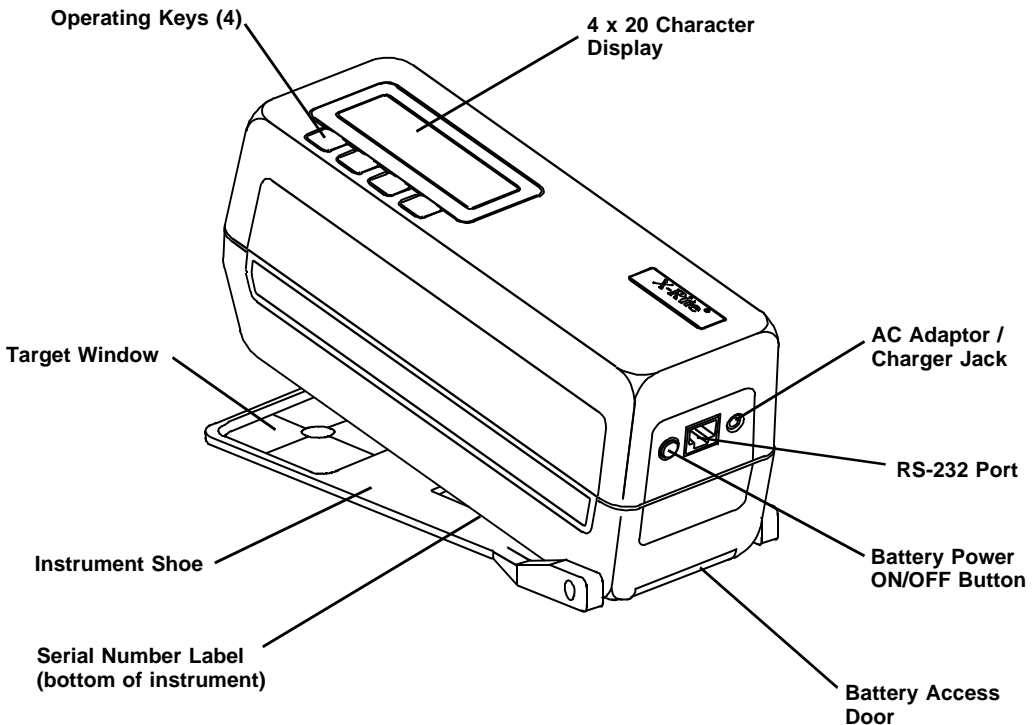

User Interface

This information will familiarize you with the typographical conventions, display function, and general terms used in this manual.

- In the text portion of this manual the SP68 key names are shown with brackets on both sides and in boldface (e.g., **[cnfg]**, etc.). When this is not applicable, the key switch will be shown as a number with quotation marks (e.g., “**Key #1**”, etc.). Switches are numbered from left-to-right.
-

- When a key is momentarily depressed, the word “press” will be used (e.g., Press **[cal]** or Press “**Key #2**”).
-

- Information that will appear in the display window will be shown with quotation marks on each side and in boldface (e.g., “**MEASURE REFERENCE SAMPLE**”).

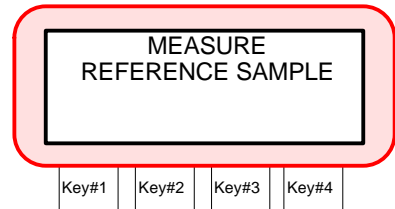

- A “hand” indicates important notes and possible operations that need to be performed before the normal operation.
-



- When a procedure is continued on the next page, an “arrow” will appear in the bottom right hand corner of the page.



What To Do First!

This manual is organized into nine sections and four appendixes. In order to make the best use of your instrument, you are urged to read all nine sections. The appendixes can be referred to as necessary.

- Section 1* - shows what the packaging contains; explains how to install the battery and apply power; unlock/lock shoe; menu and display description; and charge the batteries properly.
- Section 2* - illustrates the proper positioning required for the instrument to obtain accurate and repeatable measurements.
- Section 3* - explains all the necessary steps required for calibrating your instrument.
- Section 4* - describes the operating functions of the instrument (e.g., color space and illuminant/observer selection, reference and sample measurements, and averaging).
- Section 5* - explains tolerance adjustment and pass/fail operation.
- Section 6* - describes the procedure for storing measurements and then printing the data.
- Section 7* - shows the different configuration options and how to set them for your particular requirements. The system configuration should be set prior to taking any measurements.
- Section 8* - covers basic maintenance and troubleshooting. Read through this section and see what it contains, then refer to it as required.
- Section 9* - explains how to attach the optional bar code reader to the instrument and the proper procedure for scanning bar codes.

Appendix A - lists the technical specifications of the instrument.

Appendix B - lists error messages that may occur during operation or calibration and the proper action to take.

Appendix C - lists optional accessories available from X-Rite or an Authorized Service Center.

Appendix D - describes the color check procedure used to track color measurement performance.

SECTION 1 GETTING STARTED

Subjects covered in Section 1 are:

- 1.1 Unpacking and Inspection
- 1.2 Unlocking and Locking the Shoe
- 1.3 Installing the Battery Pack
- 1.4 Applying Power
- 1.5 Charging the Battery Pack
- 1.6 Menu Page Selection
- 1.7 Display Description

1.1 Unpacking and Inspection

After removing the instrument from the shipping carton, inspect for possible damage. If any damage is noted, contact the transportation company immediately. Do nothing more until the carrier's agent has inspected the damage. If damage is not evident, check and make sure that all items are included (refer to the parts list below and the following page for packaging illustration).

Your unit was packaged in a specially designed carton to assure against damage. If reshipment is necessary, the instrument should be packaged in the original carton.

If the original carton is not available, a new one can be obtained from X-Rite Inc.

20	1	1	1	1	1	1	1	1	1	SD01-41	CERTIFICATE OF CALIBRATION
19	1	1	1	1	1	1	1	1	1	SP68-513	BATTERY REPLACEMENT INSTRUCTIONS
18	1	-	1	-	1	-	1	-	-	SD43-22	U.L. LISTING LABEL
17	1	1	1	1	1	1	1	1	1	SD65-10	PLASTIC BAG
16	2	2	2	2	2	2	2	2	2	SD65-03	PLASTIC BAG
15	2	2	2	2	2	2	2	2	2	SD65-13	PLASTIC BAG
14											
13	1	1	1	1	1	1	1	1	1	SD43-SP68-62	REFLECTANCE LABEL
12	1	1	1	1	1	1	1	1	1	SP68-511	IMPORTANT NOTICE
11	1	1	1	1	1	1	1	1	1	SD01-04	WARRANTY REGISTRATION
10	1	1	1	1	1	1	1	1	1	SP68-500	OPERATION MANUAL
9	1	1	1	1	1	1	1	1	1	SD68-10	ENVELOPE
8	-	-	-	-	-	-	1	1	1	SP68T-00-01	SPHERE SPECTROPHOTOMETER ASSY. 8/14
	-	-	-	-	1	1	-	-	-	SP68S-00-01	SPHERE SPECTROPHOTOMETER ASSY. 4mm
	-	-	1	1	-	-	-	-	-	SP68L-00-01	SPHERE SPECTROPHOTOMETER ASSY. 14mm
	1	1	-	-	-	-	-	-	-	SP68-00-01	SPHERE SPECTROPHOTOMETER ASSY. 8mm
7	1	1	1	1	1	1	1	1	1	SP68-105-01	BLACK TRAP ASSEMBLY
6	1	1	1	1	1	1	1	1	1	SP68-62	REFLECTION STANDARD ASSY
5	-	1	-	1	-	1	-	1	-	SE30-62	AC/DC ADAPTOR 230 VAC, 50/60 Hz
4	1	-	1	-	1	-	1	-	-	SE30-61	AC/DC ADAPTOR 115 VAC, 50/60 Hz
3	1	1	1	1	1	1	1	1	1	SD67-06-01	INSTRUMENT CASE
2	4	4	4	4	4	4	4	4	4	SD200-MA58-02	CORNER PAD
1	1	1	1	1	1	1	1	1	1	SD200-MA58-01	CARTON
ITEM	QTY SP68	QTY SP68X	QTY SP68L	QTY SP68LX	QTY SP68S	QTY SP68SX	QTY SP68T	QTY SP68TX		PART NUMBER	DESCRIPTION

PARTS LIST

Packaging Illustration

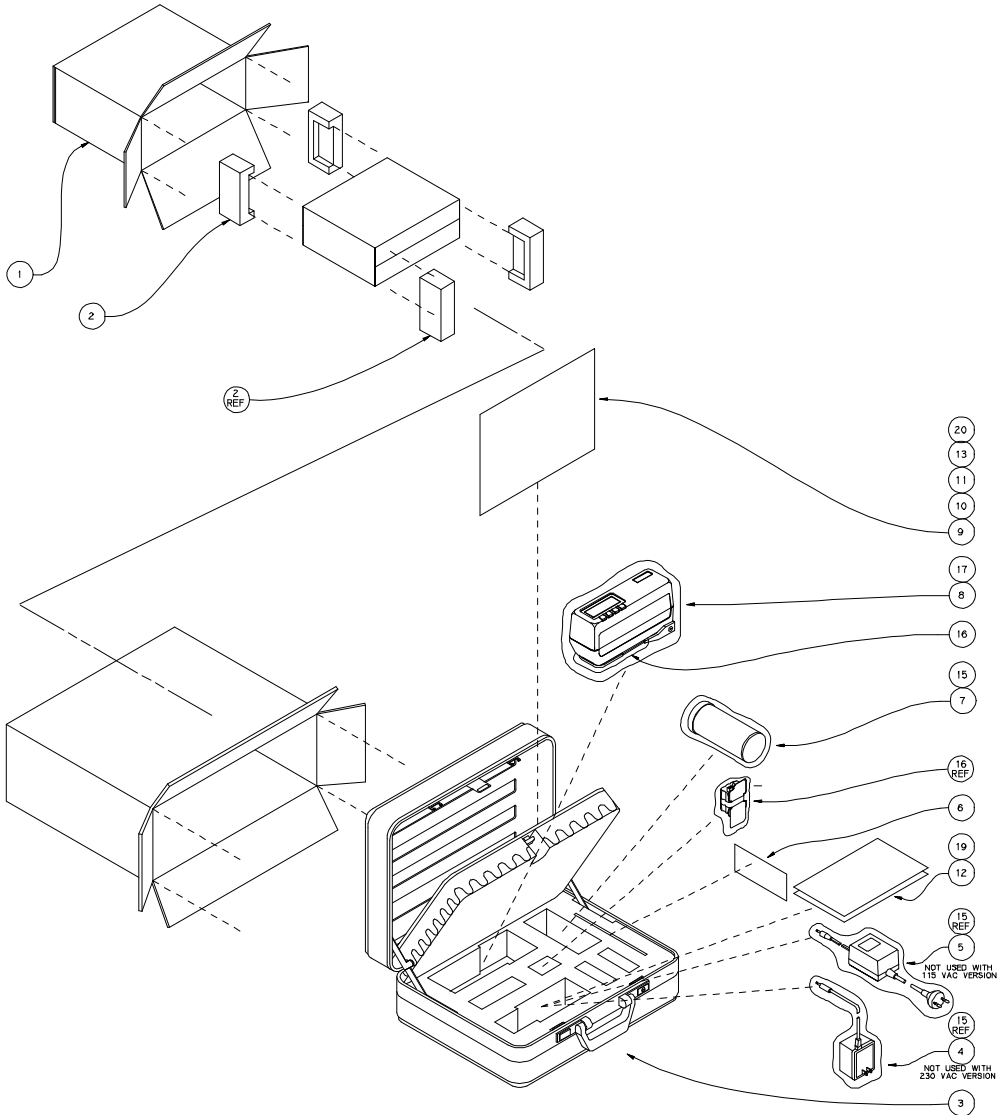

1.2 Unlocking and Locking the Shoe

The instrument is shipped from the factory with the shoe in the locked position. The shoe should always be locked next to the instrument when it is stored.

To Unlock Shoe:

1. Hold shoe [1] against instrument.
2. Slide lock button [2] on bottom of unit towards the front until it stops, then slowly release the shoe [1].

To Lock Shoe:

1. Hold shoe [1] against unit.
2. Slide lock button [2] towards the back of unit until it stops, then release shoe.

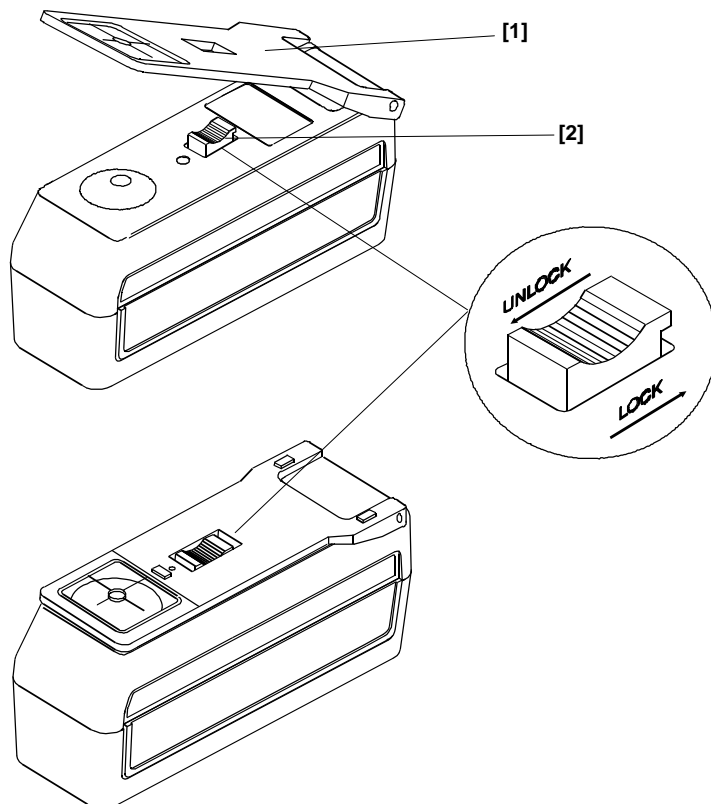

1.3 Installing the Battery Pack

The instrument is shipped from the factory with the battery pack removed. The battery pack is located in the instrument case (refer to packaging illustration for location) and **must be** installed before the instrument is used.

To Install Battery Pack:

1. Carefully place instrument on it's top and lock shoe if not locked.
2. Remove battery access cover by sliding towards rear of unit.
3. Slide battery pack into unit (with connector end down) until properly seated (refer to illustration).
4. Reinstall battery access cover by sliding into position.
5. Refer to Section 1.5 for battery charging information.

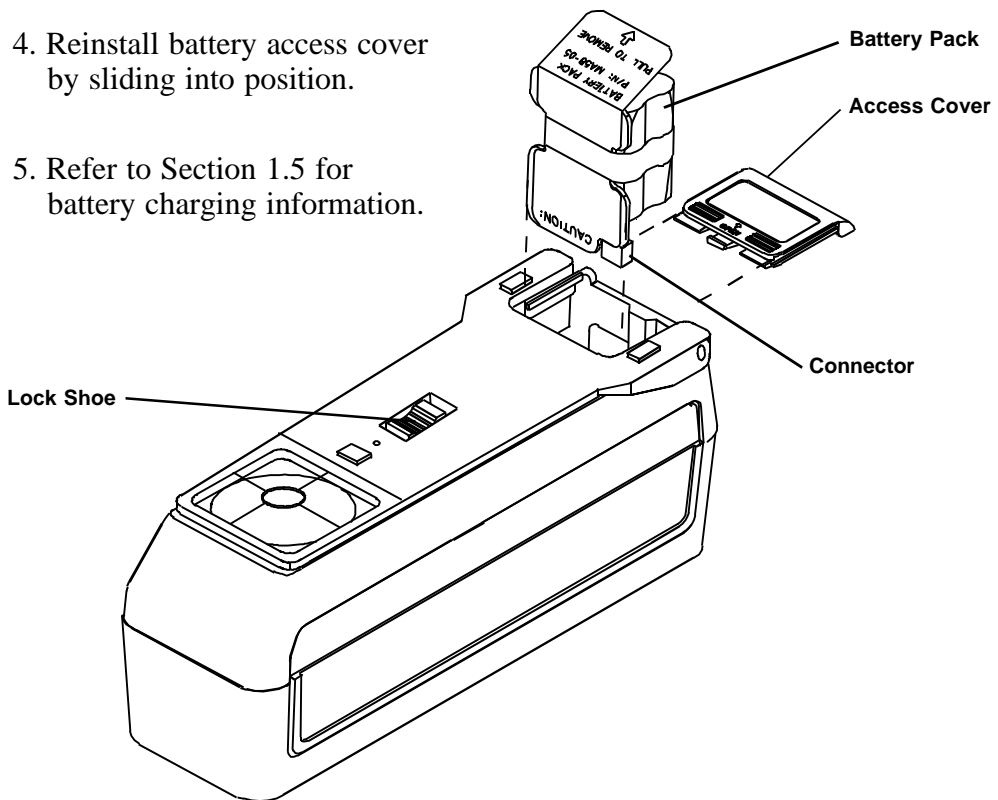

1.4 Applying Power

Battery Operation

The SP68 is activated during battery operation by pressing the “Power On/Off” switch located on the rear of the instrument. The unit will automatically turn off after 45 seconds of non-operation.

If the SP68 is allowed to power down after 45 seconds, simply taking a measurement or pressing any key will reactivate the unit. The SP68 will always wakeup in the same operation function (e.g., $L^*a^*b^*$, $L^*C^*h^\circ$, etc.) as when it powered down. The instrument can also be turned off by pressing the power On/Off switch on the rear of the unit. The switch should always be used to turn off the unit when it is going to be stored.

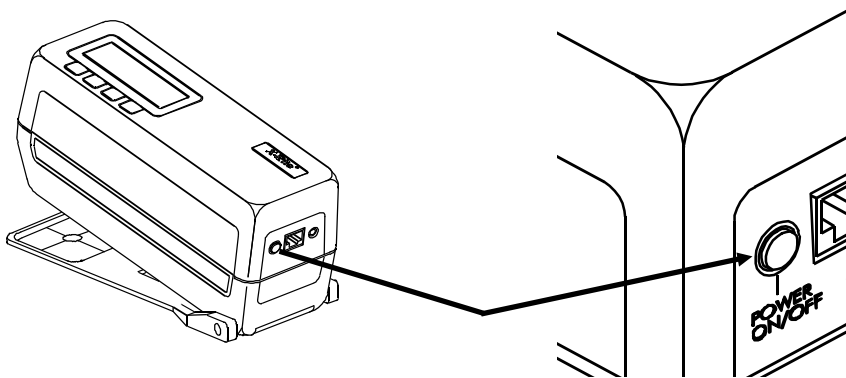

AC Operation

 The battery pack must be installed before plugging in the AC adaptor (refer to Sec. 1.3).

As long as the AC adaptor is connected to the instrument, the SP68 will remain on. The power on/off will act as a reset and return instrument to its main mode.

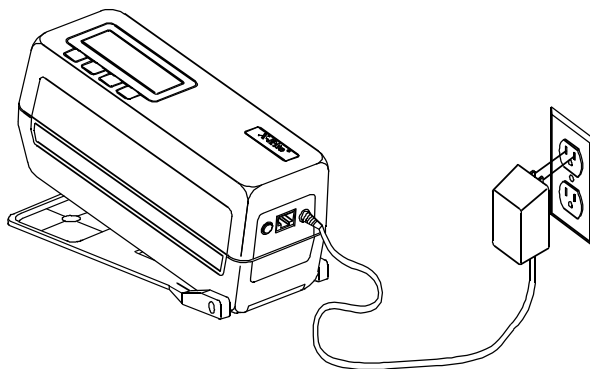

1.5 Charging the Battery Pack

“The Battery Pack Must Be Charged Before Use!”

The SP68 is powered by six nickel-metal hydride batteries in a removable battery pack. The battery pack must remain in the instrument for proper operation. The AC adaptor charges the batteries when it is plugged in, but does not eliminate the need for the batteries.

The SP68 can be operated while the batteries are being charged. Before plugging in the AC adaptor, make sure that the voltage indicated on the adaptor complies with the AC line voltage in your area. If not, contact X-Rite or your Authorized Representative.

The instrument battery pack should be fully charged (100%) in 16 hours and should provide over 500 measurements. Charging the battery pack for less than 16 hours will reduce the operating time of the unit (see charging tips).

Charging Tips

- The instrument features a “fast charge” cycle which will charge a fully discharged battery pack to 50% capacity in 4 hours. A 100% charge will be restored to a fully discharged pack in 16 hours.
- A “Battery Low” message will appear on the display when there are approximately 50 measurements left. The charger should be plugged in as soon as possible when the message appears. A “Batteries Very Low - Must Be Charged” message will appear when there is insufficient charge to operate the instrument. Once this message appears, the charger must be connected before any more measurements can be taken.
- The removable battery pack is equipped with a built-in charger jack for external charging. This allows an additional pack to be charged while one is in use in the instrument. A fully discharged pack will be completely charged in 16 hours.
- If the instrument is to be stored for an extended period of time (over 6 months), the battery pack should be removed from the unit.

NOTE: Do not plug the AC adaptor into the instrument without a battery pack installed. The instrument will not function with the battery pack out. Refer to Section 1.3 for installation.



AC Adaptor Connection Procedure

1. Plug the small connector end of the AC adaptor into the adaptor jack on the back of the instrument or the battery pack.
 2. Plug the adaptor into the AC wall outlet.
-

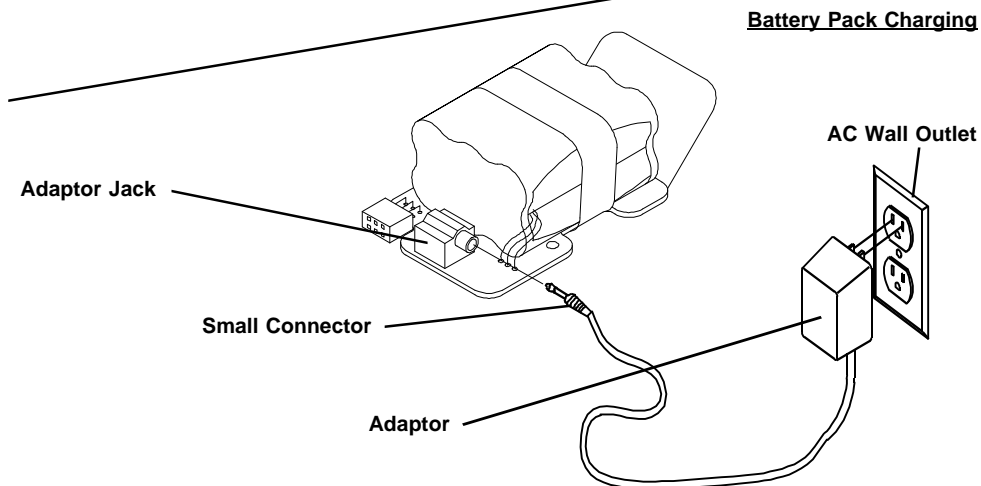
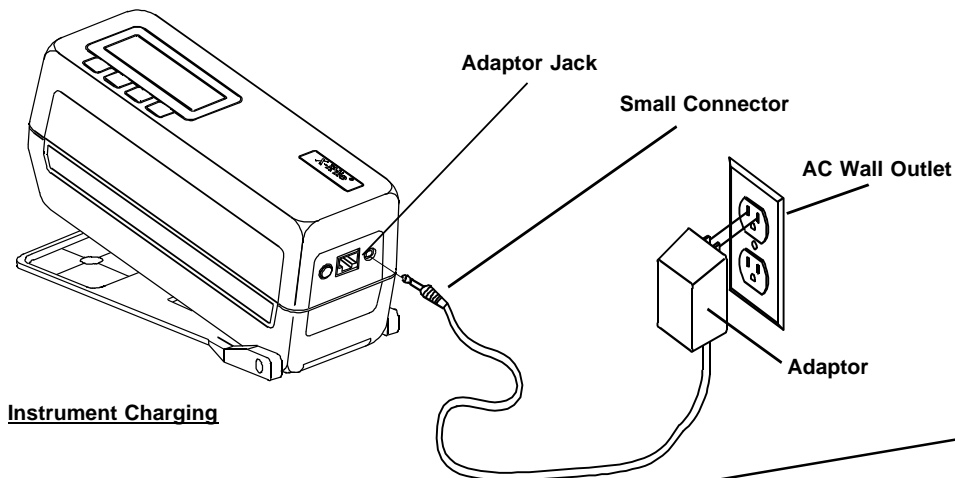

☞ The unit will not lose any of the preset information (i.e., cal, refs, etc.) if the battery pack is removed. Refer to Battery Pack Replacement in Section 8 for proper removal and installation.

1.6 Menu Page Selection

The main menu is contained in two pages. To advance through the page menus, continually press Key #1.

norm (normal) - this key will always return the display to the main screen (L*a*b*, L*C*h°, etc.).

pass/fail - this key is used to access pass/fail operation and tolerance editing.

store - storage mode allows measurement data to be stored, printed and deleted from selected groups. This function can also be used with X-Rite's QA-Master® software program.

cal (calibration) - the cal key accesses the calibration function where white calibration and zero reflectance measurements are performed.

cnfg (configuration) - operation options, printing formats, and communication parameters are set under this function.

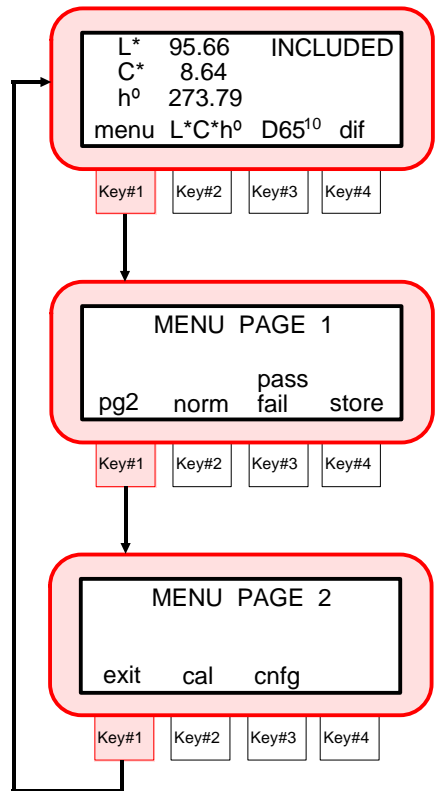

1.7 Display Description

The characters in the display above each key switch dictate which function will be selected or which action will take place when a key switch is pressed. Normally, upper-case lettering is used for display messages, and lower-case lettering is used for menu options that are selectable by the user.

Sphere geometry (specular included or specular excluded) is selected in the Operation Options, Section 7.2.

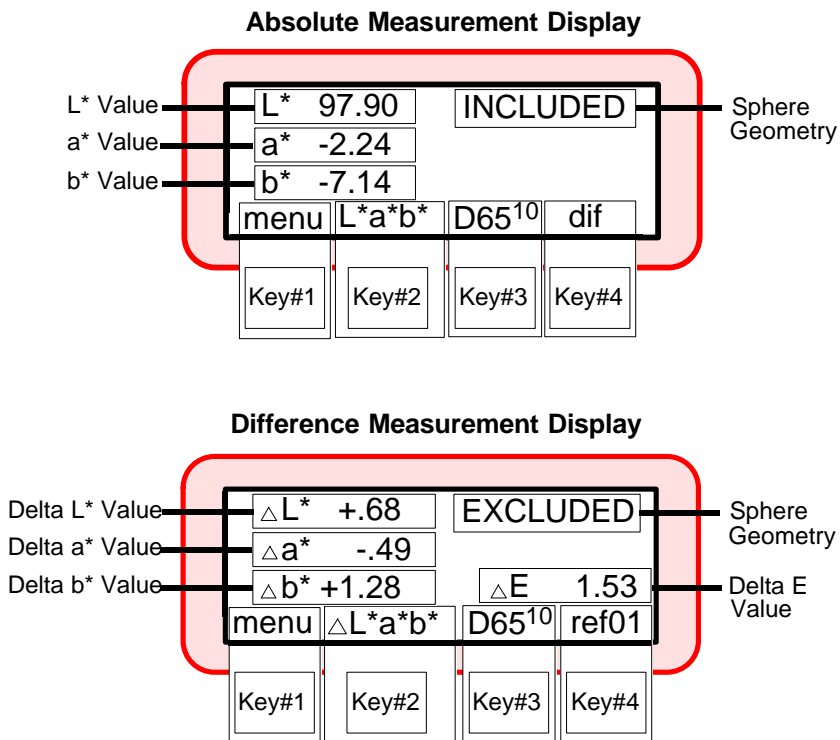

SECTION 2

INSTRUMENT POSITIONING & MEASUREMENT TECHNIQUES

General

The variety of items that the SP68 can measure is almost endless. However, in order to obtain accurate and repeatable measurements, the bottom of the shoe must be:

- Parallel* with the surface to be measured if the surface is *flat*.
- Tangent* to the surface to be measured if the surface is *curved*.

The reason for this is that any movement during measurement can cause the reading to vary. To obtain the most accurate and repeatable measurements, there are a few guidelines you can follow.

If the item to be measured is smaller than the shoe, you may want to make a platform (the same height of the item) for the instrument to sit on. If the item to measure is curved, you may want to make a jig for the item to rest in.

Specular Excluded Mode

Measurements taken in the specular component excluded mode are inherently geometry sensitive. The specular excluded mode will detect slight differences in surface texture. If specular excluded is used, the averaging mode should also be used (e.g., average 3-5 readings per measurement).

 The inherent sensitivity to surface geometry (i.e.; pits, scratches, textures, etc.) is greatly enhanced in the small area view model (SP68S), and will result in increased measurement variability. For this reason, use of the specular excluded mode is not recommended for this model.

Dark Colors

For best accuracy and repeatability when measuring dark or high chroma colors, the instrument should be calibrated more frequently. Also, the “auto averaging” mode should be used when measuring dark and high chroma colors. When set to auto averaging, the instrument will automatically require three measurements if an X, Y, or Z value of 2.5% or less is detected. Refer to Section 7.2 for averaging setup.

Non-Uniform Samples

Non-uniform samples such as plaids and patterned materials should also be measured using the averaging mode (3-5 readings), for both the specular included and excluded modes.

Positioning Example

Shown below is one method that can be used to position the instrument when measuring a paint chip.

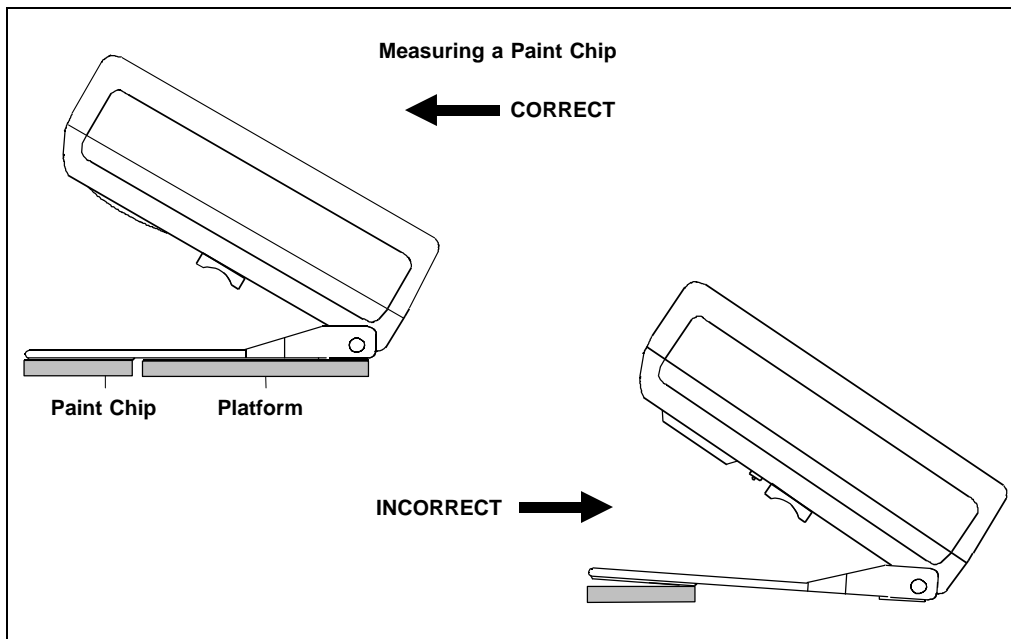

SECTION 3

CALIBRATION

Subjects covered in Section 3 are:

- 3.1 Positioning the Instrument on the White Calibration Standard
- 3.2 Positioning the Instrument on the Black Trap
- 3.3 Calibration Procedure

The SP68 should be calibrated to the X-Rite white standard and black trap the first thing each day and every four hours of operation thereafter (more frequently if measuring dark or high chroma colors). In any event, a "**NEED CALIBRATION**" message will appear in the display when:

- The calibration procedure has not been performed for 4 hours.
- A 5°C change in temperature has occurred since last calibration.
- Zero reflectance or white cal is measured improperly.

Whenever this message appears the calibration procedure should be performed before another measurement is taken to ensure accuracy.

Calibration Notes:

- Dirt or dust in the optics area will cause an inaccurate calibration reading. Refer to Section 8 Optics Cleaning.
- **The White Reflection Standard is dramatically affected by smudge marks, dust, and finger prints.** The standard should be cleaned periodically using a mild soap and warm water solution, thoroughly rinsed with warm water, and wiped dry with a lint free cloth. You must let the standard dry completely before taking a calibration reading. Return standard to its protective envelope.
- The black trap should be cleaned periodically to remove any dust or contamination that may have gotten in the tube. Clean the trap with compressed air or wipe with dry lint free cloth. Always store the black trap with the cap on the measurement opening.
- Do not move the SP68 while taking a calibration measurement. If motion is detected an error message will be displayed and calibration aborted.

3.1 Positioning the Instrument on the White Standard **—**

You must set the SP68 on the white standard so that the rubber pads on the bottom of the shoe reside on the standard, and the target is centered on the circle. If you do not, the unit will rock and cause an erroneous reading of the standard.

Positioning Procedure:

- 1) Center the target window on the White circle, making sure that the rubber pads are completely on the standard.

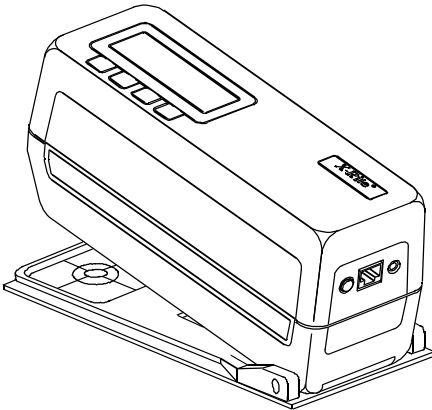

CORRECT!

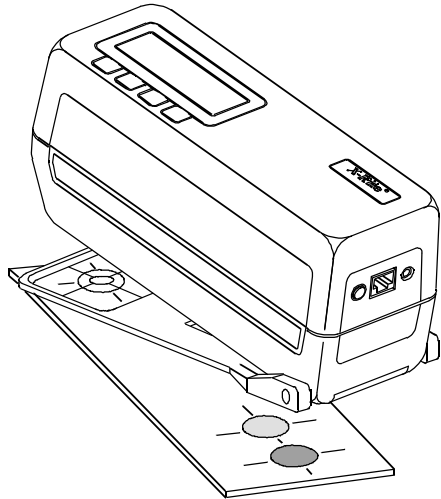

INCORRECT!

- 2) Take the measurement.

X-Rite Reflection Standard

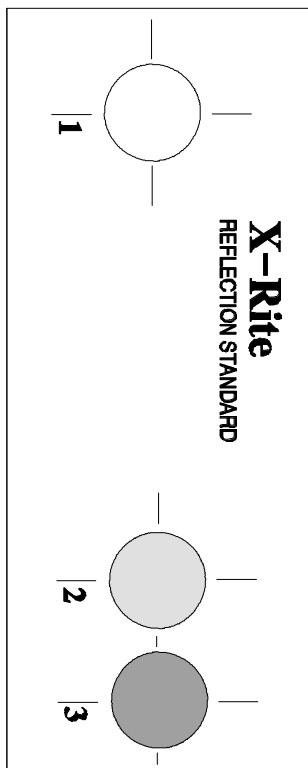

X-Rite
Reflection Standard
P/N SP68-62
Serial No. AXXXXP-XXXXX
Date XX/XX/XX

WAVE [nm]	REFL [%]
380	96.48
400	76.92
410	82.04
420	86.10
430	87.93
440	87.14
450	87.58
460	87.97
480	88.49
500	88.95
530	89.13
540	89.02
560	88.78
580	89.34
600	87.80
620	87.32
640	86.98
660	86.55
680	86.10
700	85.62
710	85.18

CALIBRATION CHECK

D65/10 (WHITE)

L*

a*

b*

Instrument Model No.

Instrument Serial No.

COLOR CHECK

Refer to section in operation manual appendix for procedure to obtain reference values.

DATE: _____ TEMP: _____

ILLUM/OBS: _____ APERT: _____

REFERENCES VALUES			
STEP	L*	a*	b*
1 (White)	<input style="width: 50px;" type="text"/>	<input style="width: 50px;" type="text"/>	<input style="width: 50px;" type="text"/>
2 (Blue)	<input style="width: 50px;" type="text"/>	<input style="width: 50px;" type="text"/>	<input style="width: 50px;" type="text"/>
3 (Brown)	<input style="width: 50px;" type="text"/>	<input style="width: 50px;" type="text"/>	<input style="width: 50px;" type="text"/>

Notes: _____

IMPORTANT!
The standard is dramatically affected by smudge marks and dust; and must be kept clean.

The Calibration Values for the white spot are affected by the environment and cleaning method of the standard.

If the white spot does not measure correctly, it could be that the unit needs to be calibrated; there is dust in the optics; or the standard has smudge marks or is dirty.

The ceramic standard should be cleaned using a mild soap and warm water solution, thoroughly rinsed with warm water, and wiped dry with a clean, lint free cloth.

3.2 Positioning the Instrument on the Black Trap

The aperture in the target window must be centered (as close as possible) over the black trap opening. Make sure that the base of the trap is setting on a flat, level surface. Any movement of the trap during measurement may cause an error message to display.

- 1) Center the aperture in the target window over the black trap by holding the outside edge of the shoe with your left hand.

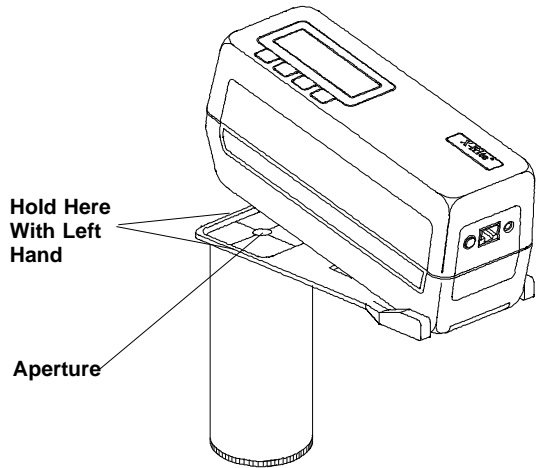

- 2) Lower the instrument to the shoe and hold until the measurement is taken.

 The black trap should be cleaned periodically with clean, dry compressed air. Or, wiped clean with a lint free cloth.

A **“WARNING! LARGE CHANGE CHECK FOR DUST”** error message will occur during zero reflectance measurement if dust is detected in the trap or optics, or if the instrument experiences normal drift. If the message appears, clean optics and black trap and measure zero again.

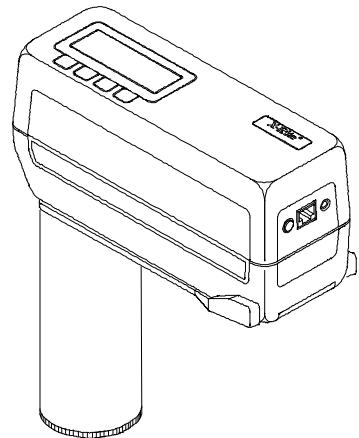

3.3 Calibration Procedure

To perform a calibration:

- 1) Make sure white cal standard and black trap are clean (see calibration notes Section 3).

-
- 2) Press **[menu]** key #1 twice to enter **MENU PAGE 2**.

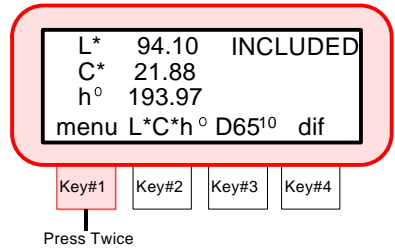

- 3) Press **[cal]** key #2 to enter calibration function.

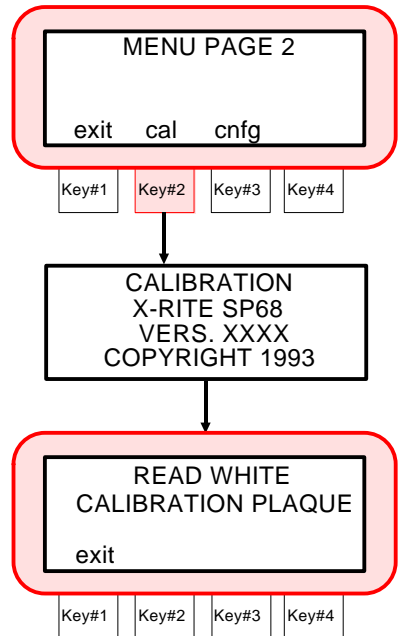

- The software datecode and copyright are momentarily displayed.

- “**READ WHITE CALIBRATION PLAQUE**” is displayed.

☞ Pressing **[exit]** key #1 will abort the calibration procedure and calibration will not be updated.



- 4) Position the instrument on the white standard and take measurement. Refer to Positioning the Instrument on the White Cal Standard Section for additional information.

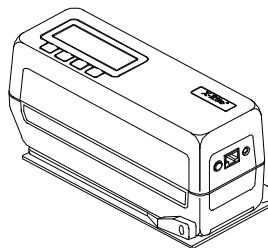

-
- **“READING WHITE PLAQUE ”** is displayed, then **“READING COMPLETE.”**

☞ If an error message occurs during calibration, try reading plaque again. If error message still occurs, refer to Display Messages in Appendix B.

- **“READ ZERO REFLECTANCE ”** is displayed.

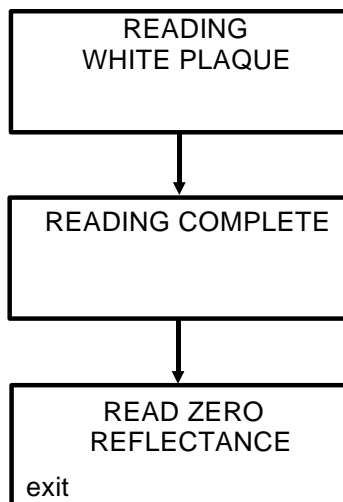

☞ The black trap should be cleaned periodically with clean, dry compressed air. Or, wiped clean with a lint free cloth.

A **“WARNING! LARGE CHANGE CHECK FOR DUST”** error message will occur during zero reflectance measurement if dust is detected in the trap or optics, or if the instrument experiences normal drift. If this message appears, clean optics and black trap and measure zero again.

- 5) Place the instrument over the black trap. Refer to Positioning the Instrument on the Black Trap Section.

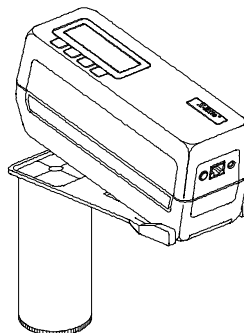

- 6) Lower the instrument to the target window to take measurement.

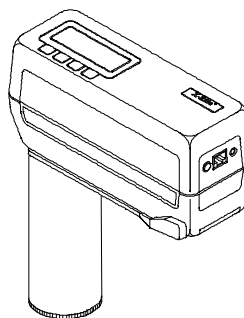

- **“READING ZERO REFLECTANCE”**, **“ZERO REFLECTANCE CALIBRATION UPDATED”**, and **“WHITE CALIBRATION UPDATED”** is displayed.

☞ If an error message occurs during the zero reflectance measurement, clean optics and/or black trap and try reading again. If error message still occurs, refer to Display Messages in Appendix B.

If **“PLEASE WAIT XX (1-30) SECONDS”** is displayed during calibration, continue to hold in down position until calibration reading is over. This will only occur if the calibration procedure is performed within 30 seconds of a previous measurement.

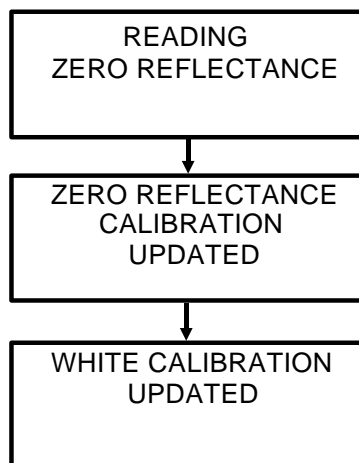

SECTION 4 NORMAL OPERATION

Subjects covered in Section 4 are:

- 4.1 Color Space Selection
- 4.2 Illuminant/Observer Selection
- 4.3 Reference Entry
- 4.4 Sample Measurement
- 4.5 Using Measurement Averaging

4.1 Color Space Selection

There are eight colorimetric systems (absolute and difference) that can be selected when displaying measurement data. Each momentary depression of “Key #2” will page through: L*a*b*, L*C*h°, XYZ, Lab (Hunter), Wht, Yel, Yxy and ΔE_{CMC} . Pressing [dif] key #4 will display the difference values for the selected color space.

☞ The instrument is shipped from the factory with XYZ, Hunter Lab, Wht, Yel and Yxy disabled. Refer to Section 7.2, Operation Options to enable or disable color spaces.

Yellowness will only allow illuminant/observer combination C².

To select a color space:
- Repeatedly press
“Key #2.”

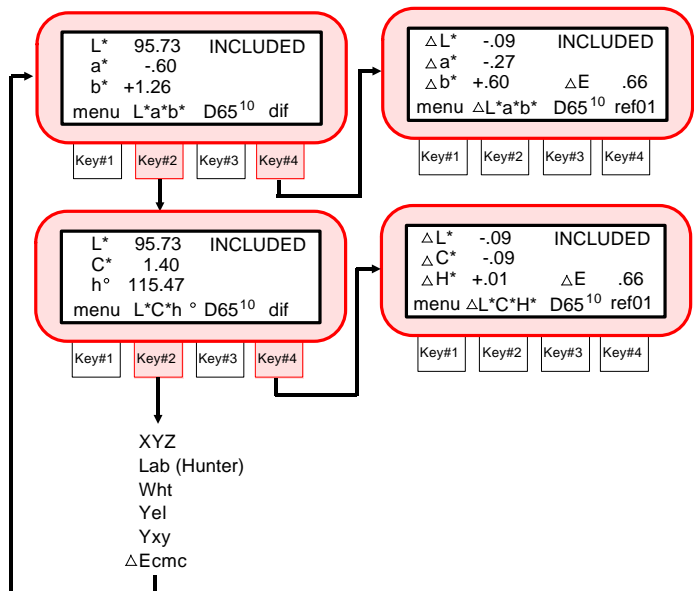

4.2 Illuminant/Observer Selection

The SP68 has eighteen illuminant/observer combinations available. Any combination can be selected after a measurement to view data under different conditions.

To select an illuminant/observer:

- Repeatedly press “Key #3.”

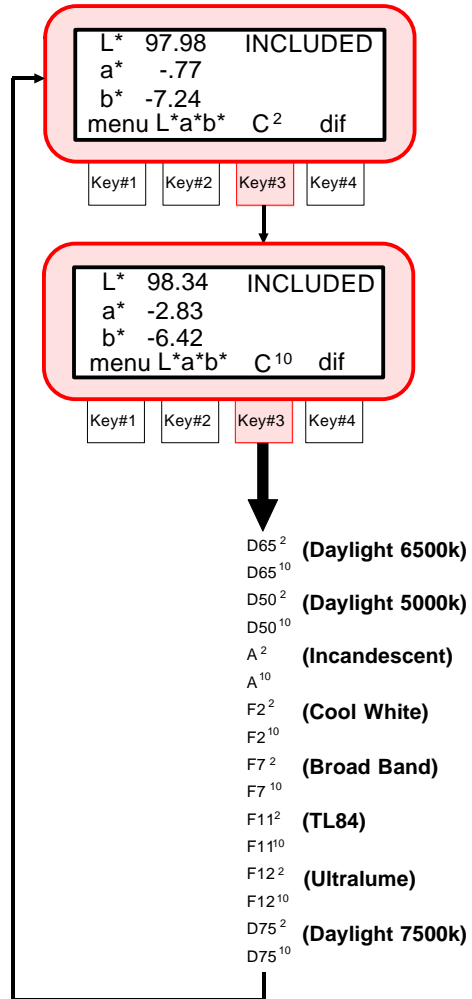

☞ All illuminant/observer combinations may not display. Certain combinations may be turned off in Operation Options, Section 7.2. D65¹⁰, A¹⁰, and F2¹⁰ are preset on at the factory.

4.3 Reference Entry

The SP68 can display the difference between a reference and a sample. In order to display these differences the reference must first be entered into memory. There are 50 locations to store references.

Measured references are stored spectrally and the tristimulus values are recalculated each time a different illuminant/observer is selected. Manually entered references are stored only in the selected color space and illum/obs.

The instrument can be set to operate in *“auto reference enabled”* mode. In this mode, the unit will automatically select the closest reference during a measurement. In *“auto reference disabled”* mode, the operator has to manually select the reference location before a measurement. Once you have selected a reference manually, that reference will be used until a different reference is selected.

Refer to Setting Operation Options Section 7.2 for manual and auto reference selection.

To measure a reference:

- 1) Select desired color space and illuminant/observer.

 - 2) Press **[dif]** key #4 to display color difference.

 - 3) Press the **[ref#]** key #4 to enter reference selection menu.

 - 4) Press **[↓]** key #2 or **[↑]** key #3 to select reference location. After selection, press **[edit]** key #4 to enter reference entry menu.

- **“MEASURE REFERENCE SAMPLE”** is displayed.
 - Continue with Step 5 to manually enter reference values. Advance to Step 6 to measure a reference.

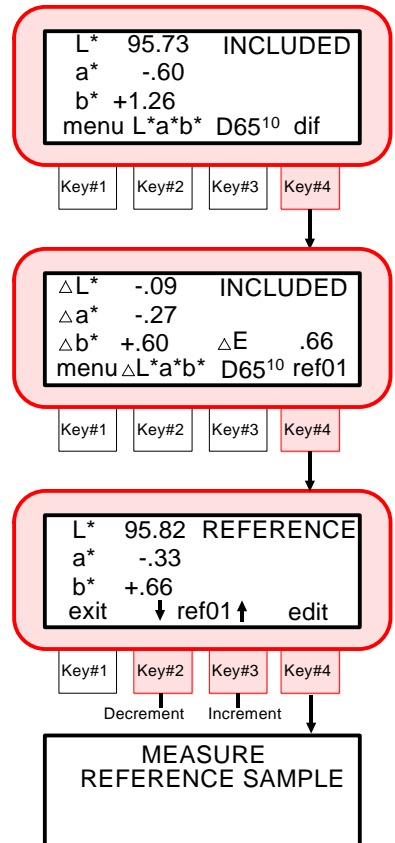

5) Manual Entered Reference

☞ The “+”, “-”, and “next” key descriptions will not display if “**AUTO REFERENCE**” is turned “on” in modes (Sec. 7.2).

- Press [**next**] key #4 to move cursor to desired attribute.
- Press [**+**] key #2 to increase the value.
- Press [**-**] key #3 to decrease the value.
- After values are entered, advance to Step 7.

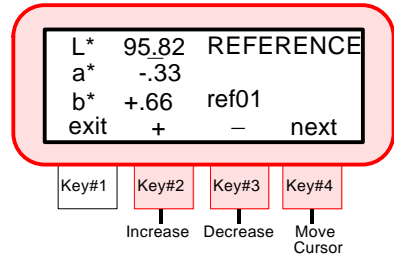

6) Reference Measurement

- Position the target window over reference to measure.
- Lower unit to target window and hold compressed.
- Release unit from reference after “**READING COMPLETE**” is displayed.

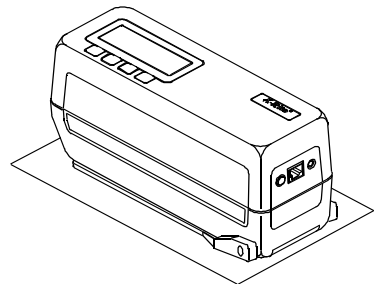
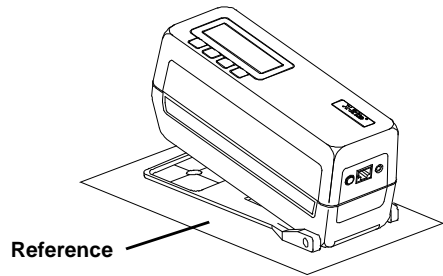

☞ If an error message occurs during the measurement, try reading reference again. If error message still occurs, refer to Display Messages in Appendix B.

7) The reference data is entered, and instrument is ready for a sample difference measurement.

- Press [**exit**] key #1 twice to return to normal operation.

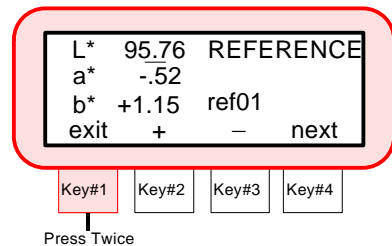

4.4 Sample Measurement

Measurement data can be displayed as absolute or difference for the selected sphere geometry (included or excluded). The SP68 uses “**INCLUDED**” as the factory default. Refer to Operation Options, Section 7.2 to change sphere geometry if required.

When the SP68 is interfaced to a serial printer, data will print after each measurement. The data that is printed is based on the Printout Options selected (see Section 7.3).

If measurement data storage is required, refer to Section 6.

To take a sample measurement:

- 1) If taking a difference measurement, make sure a reference is entered into the instrument (refer to Section 4.3 Reference Entry).
-

- 2) Select color space by pressing “**Key #2.**” Select illuminant/observer by pressing “**Key #3.**”

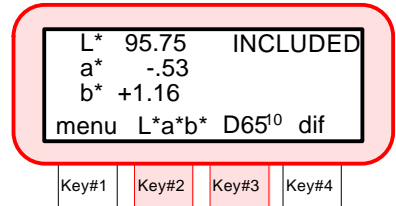

- 3) Position target window over sample.

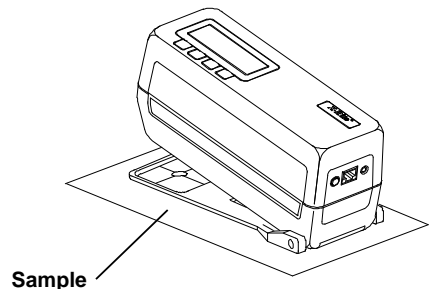

4) Lower unit to target window and hold compressed.

- Release unit from sample after “READING COMPLETE” is displayed.

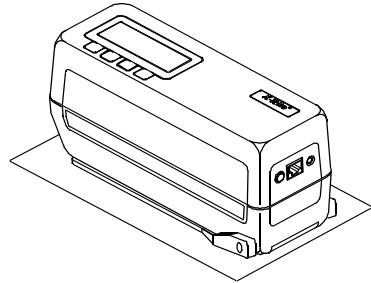

☞ If an error message occurs during the measurement, try reading sample again. If error message still occurs, refer to Display Messages in Appendix B.

5) The instrument will display the absolute or difference measured.

- The sample data can be viewed under different illuminant/observer combinations by pressing “Key #3.” The data can also be viewed in a different color space by pressing “Key #2.”

☞ If auto reference is “on”, the instrument will select the reference that is the closest match to the sample.

L* 95.74	INCLUDED
a* -.52	
b* +1.14	
menu L*a*b* D65 ¹⁰ dif	

Key#1 Key#2 Key#3 Key#4

L* 95.76	INCLUDED
a* -.18	
b* +1.00	
menu L*a*b* A ¹⁰ dif	

Key#1 Key#2 Key#3 Key#4

ΔL* -.02	INCLUDED
Δa* .00	
Δb* -.01	ΔE .02
menu ΔL*a*b* D65 ¹⁰ ref01	

Key#1 Key#2 Key#3 Key#4

- ΔL*a*b*, ΔL*C*h* and ΔEcmc can display measurement differences as “words” if desired. Refer to Section 7.2 for information on Delta Expression.

ΔL* darker	INCLUDED
Δa* >>grn	
Δb* >>yel	ΔE .02
menu ΔL*a*b* D65 ¹⁰ ref01	

Key#1 Key#2 Key#3 Key#4

4.5 Using Measurement Averaging

☞ Measurement Averaging must be activated in Operation Options before averaging can take place. Refer to Section 7.2 for procedure.

When averaging is activated, the averaging sequence will be required for all functions (i.e., normal, storage, and pass/fail).

Averaging should be used when measuring non-uniform samples, textured materials, and any dark or high chroma color, especially when specular excluded mode is used. When set to auto averaging, the instrument will automatically require three measurements if an X, Y, or Z value of 2.5% or less is detected.

The following example has an average setting of “2.”

To take an average measurement:

- 1) Select measurement function (i.e, normal, storage, or pass/fail).
-

- 2) Position target window over the first sample area to be measured.

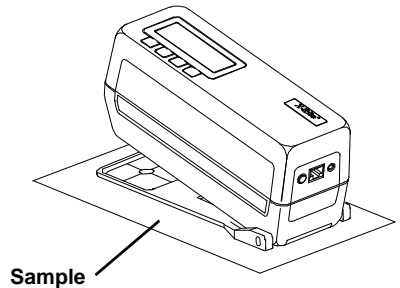

- 3) Take measurement by lowering unit to target window on sample.

- Release unit off of first area on sample when “**READING COMPLETE**” is displayed.

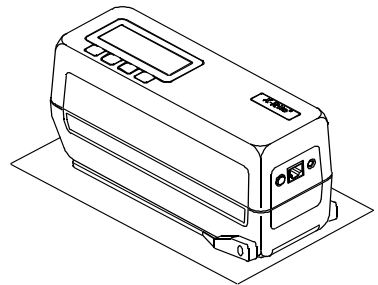

4) “**MEASURE SAMPLE 2 OF 2**” is displayed.

☞ Measurement averaging can be aborted at anytime by pressing [**reset**] key #1. The last measurement taken will be the data that is displayed.

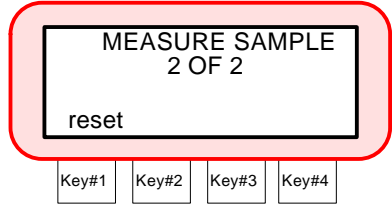

5) Center target window over second area on sample.

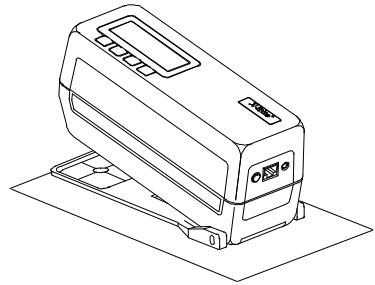

6) Take measurement.

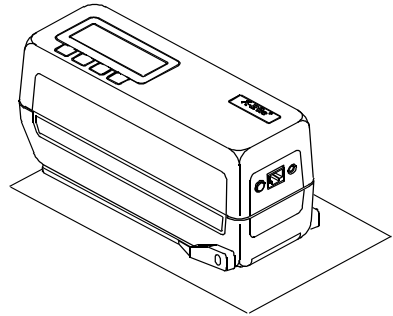

7) “**AVERAGE CALCULATED**” is displayed and then the averaged measurement data.

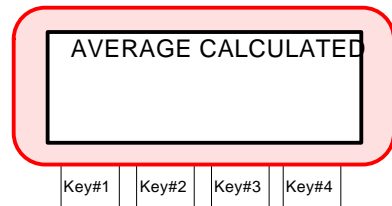

SECTION 5

PASS/FAIL OPERATION

Subjects covered in Section 5 are:

- 5.1 Adjusting Tolerance Values
- 5.2 Pass/Fail Measurement

The Pass/Fail feature will indicate a pass or fail signal on a sample measurement based on the tolerance assigned to a reference.

Tolerance limits can be set for all available color spaces.

5.1 Adjusting Tolerance Values ---

The tolerance adjustment feature allows the user to select the color space, illum/obs and tolerance values for each reference.

- $\Delta L^*a^*b^*$ and $\Delta L^*C^*H^*$ method allows pass/fail indication on ΔE or all attributes.
- ΔXYZ or ΔYxy method allows pass/fail indication on all attributes.
- ΔWht or ΔYel method allows pass/fail indication on available attributes.
- ΔE_{CMC} method allows adjustment of “l” (lightness factor) and “c” (chromaticity factor), and pass/fail based on “cf” (commercial factor).

The pass/fail method selected will cause the tolerance editing procedures to differ. Each tolerance method selected will be covered separately. The initial tolerance procedure will be covered in steps 1 - 4. Thereafter, each tolerance method will start at Step 5.

To adjust tolerance values:

1) At “MENU PAGE 1”, press [pass/fail] key #3 to enter pass/fail option.

2) Press [tol] key #4 to enter the “TOLERANCE MODE” screen.

3) Select reference by pressing [↓] key #2 to decrement or [↑] key #3 to increment. The available references are: 1 through 50.

- Press [edit] key #4 to advance to “DEFINE TOLERANCE” screen.

4) Select tolerance method by pressing Key #2. The available methods are: $\Delta L^*a^*b^*$, $\Delta L^*C^*H^*$, ΔXYZ , ΔYel , ΔWht , ΔYxy and ΔE_{CMC} . Select illum/obs combination by pressing Key #3.

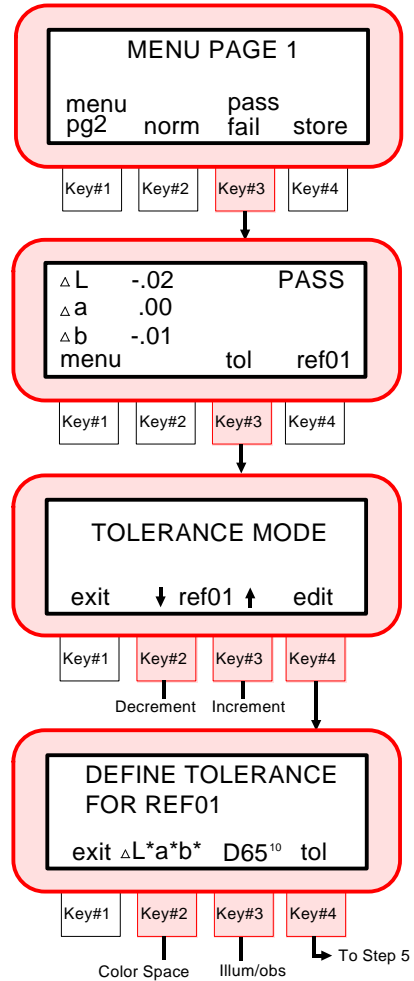

IMPORTANT!
The following pages cover each tolerance method separately.



PASS/FAIL METHOD = $\Delta L^*a^*b^*$ or $\Delta L^*C^*H^*$

☞ The $\Delta L^*a^*b^*$ and $\Delta L^*C^*H^*$ tolerance limit editing is similar and will be covered in the same procedure.

- 5) Press **[tol]** key #4 to advance
 “PASS/FAIL METHOD” screen.

- 6) Press **Key #2** to select Pass/Fail
 method.

- Press **[exit]** key #1 to advance to
 “PASS FAIL LIMITS” screen.

- 7) Set tolerance limits by pressing
 the **[next]** key #4 to move cursor
 to desired attribute. Press **[+]** key
 #2 to increase value or **[-]** key #3
 to decrease value.

- Press **[exit]** key #1 twice to save
 and exit tolerance procedure.

OR

- 7) Set tolerance limit for ΔE . Press
[+] key #2 to increase value or **[-]**
 key #3 to decrease value.

- Press **[exit]** key #1 twice to save
 and exit tolerance procedure.

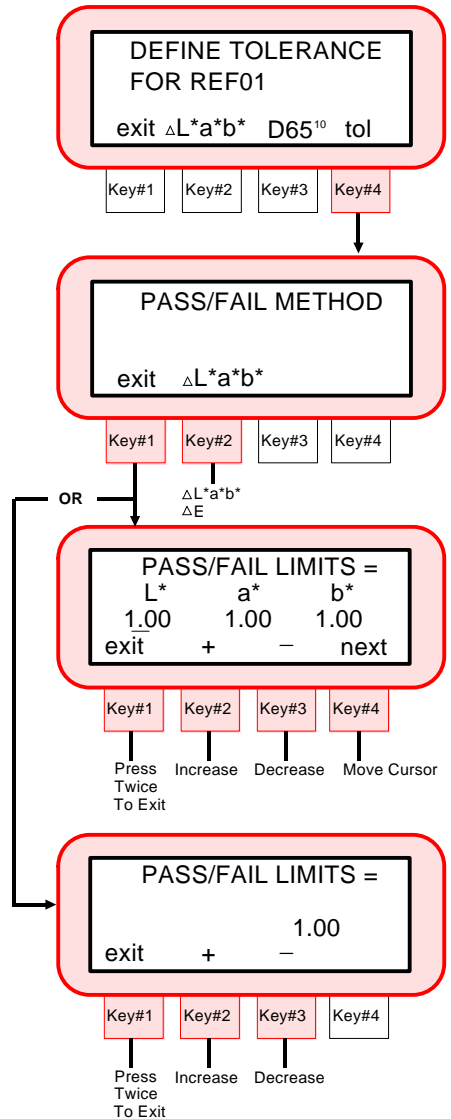

PASS/FAIL METHOD = ΔXYZ or ΔYxy

☞ The ΔXYZ and ΔYxy tolerance limit editing is similar and will be covered in the same procedure.

- 5) Press **[tol]** key #4 to advance
 “PASS/FAIL LIMITS” screen.

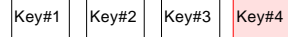
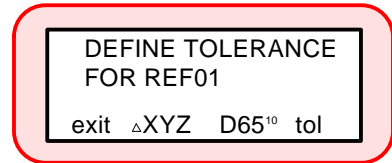

- 6) Set tolerance limits by pressing the
[next] key #4 to move cursor to
 desired attribute. Press **[+]** key #2
 to increase value or **[-]** key #3 to
 decrease value.

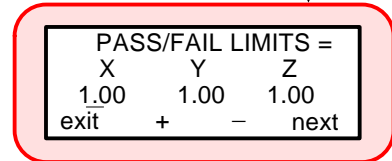

- Press **[exit]** key #1 twice to save
 and exit tolerance procedure.

Press
Twice
To Exit

Increase

Decrease

Move Cursor

PASS/FAIL METHOD = ΔYel or ΔWht

☞ The ΔYel and ΔWht tolerance limit editing is similar and will be covered in the same procedure. Whiteness only has one field to edit.

- 5) Press **[tol]** key #4 to advance
 “PASS/FAIL LIMITS” screen.

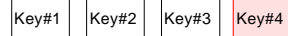
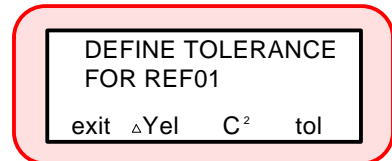

- 6) Set tolerance limits by pressing the
[next] key #4 to move cursor to
 desired attribute. Press **[+]** key #2
 to increase value or **[-]** key #3 to
 decrease value.

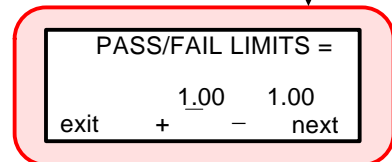

- Press **[exit]** key #1 twice to save
 and exit tolerance procedure.

Press
Twice
To Exit

Increase

Decrease

Move Cursor

PASS/FAIL METHOD = ΔE_{CMC}

5) Press **[tol]** key #4 to advance to “PASS/FAIL LIMITS” screen.

6) Set tolerance values by pressing the **[next]** key #4 to move cursor to desired “cf”, “l”, & “c” attribute. Press **[+]** key #2 to increase value or **[-]** key #3 to decrease value.

- Press **[exit]** key #1 twice to save and exit tolerance procedure.

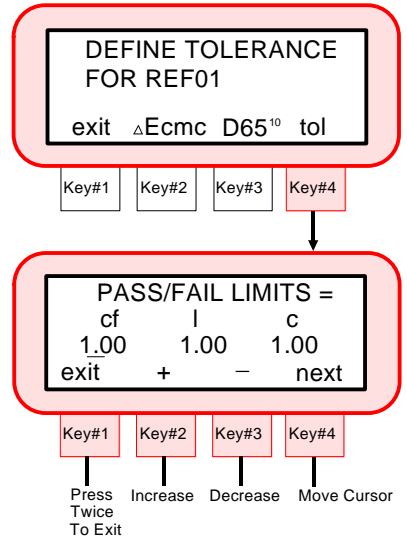

5.2 Pass/Fail Measurement

The Pass/Fail measurement will indicate a pass or fail signal based on the tolerance limits set on the selected reference.

When the SP68 is interfaced to a serial printer, data will print after each measurement. The data that is printed is based on the Printout Options selected (see Section 7.3).

If measurement data storage with pass/fail indication is required, refer to Section 6.

To take a pass/fail measurement:

☞ References must be measured and tolerances edited before a pass/fail measurement will display usable data. Refer to Sections 4.3 and 5.1.

- 1) Press **[pass/fail]** key #3 at the **MENU PAGE 1** level to enter pass/fail function.

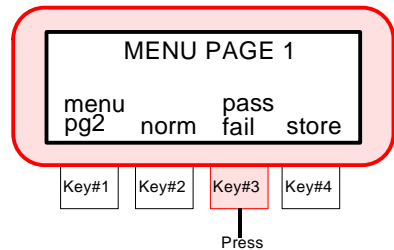

- 2) The Pass/Fail measurement screen is displayed.

☞ A reference must be selected if "Auto Reference" is disabled in Operation Options. Press the **[ref#]** key #4 to access reference menu.

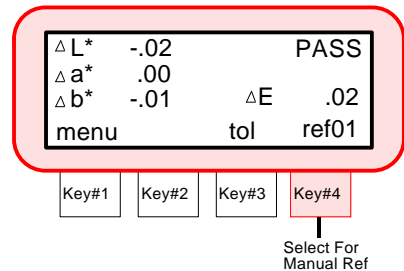

- 3) Take measurement by lowering unit to sample.

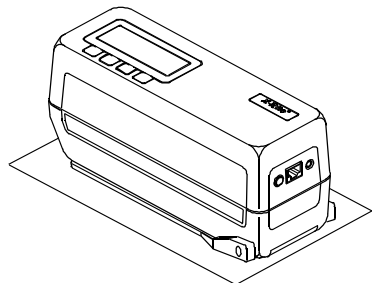

- 4) The difference data and a **“PASS”** or **“FAIL”** (1 long beep) will display to indicate sample status.

ΔL^*	-0.05		PASS
Δa^*	-0.04		
Δb^*	+0.08	ΔE	.10
menu		tol	ref01

Key#1	Key#2	Key#3	Key#4
-------	-------	-------	-------

- $\Delta L^*a^*b^*$, $\Delta L^*C^*h^*$ and ΔE_{cmc} tolerance methods can display measurement differences as “words” if desired. Refer to Section 7.2 for information on Delta Expression.

ΔL^*	darker		PASS
Δa^*	>>grn		
Δb^*	>>yel	ΔE	.10
menu		tol	ref01

Key#1	Key#2	Key#3	Key#4
-------	-------	-------	-------

SECTION 6

STORAGE OPERATION

Subjects covered in Section 6:

- 6.1 Storing Measurements
- 6.2 Deleting Stored Measurements
- 6.3 Printing Stored Measurements
- 6.4 Tagging and Storing Operation (with optional BCR)
- 6.5 QA-Master “Run Job” Operation

Storage operation allows measurement data to be stored, deleted and output to a computer or printer.

When the SP68 is used in conjunction with X-Rite’s QA-Master[®] software program, stored measurement data is “uploaded” directly into the application for visual analysis.

Data that is displayed during storage operation depends on what storage method is selected in Operation Options (Section 7.2). If “Store Data Only” is selected, the data displayed will be based on the last color space selected in normal operation. If “Store with Pass/Fail” is set, the displayed data is based on the closest pass/fail reference.

6.1 Storing Measurements

Storage allows sample measurements to be assigned to group numbers. Once in storage mode, the operator can randomly select group numbers and measure as many samples as desired in the selected group. The instrument allows a maximum of 999 samples to be stored in 20 groups.

Stored sample measurements can also have scanned tags attached by use of the “optional” bar code reader (BCR). Group names are assigned by scanning tags. Individual measurements can have up to 6 tags attached. Refer to Section 6.1 for additional information on BCR tagging.



To store a measurement:

1) Select desired color space and illuminant/observer.

☞ Stored data will display in the last color space and illuminant/observer combination selected in normal function.

2) Press **[store]** key #4 at the **MENU PAGE 1** level to enter storage function.

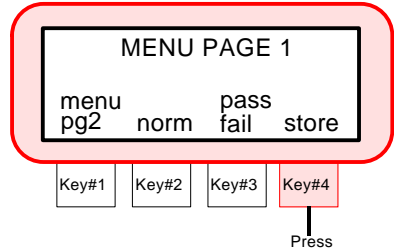

☞ If “STORE WITH PASS/FAIL” and “AUTO REFERENCE DISABLED” are selected in Operation Options (Section 7.2), continue with Step 3. If Auto Reference is Enabled, advance to Step 4.

3) Press **[edit]** key #4 to enter “SELECT EDIT OPTION” screen.

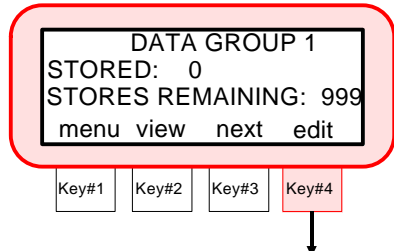

- Press **[ref #]** key #2 to enter “TOLERANCE MODE” screen.

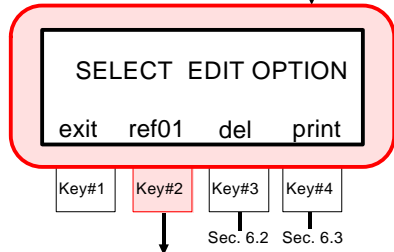

- Select desired reference for pass/fail indication. Press **[↓]** key #2 to decrement and **[↑]** key #3 increment through reference #'s.

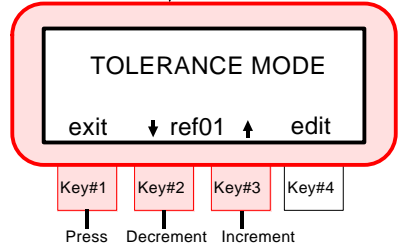

- Press **[exit]** key #1 to return to “DATA GROUP #” screen.

- 4) Select desired data group number by repeatedly pressing **[next]** key #3.

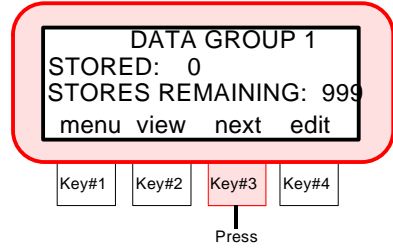

- 5) Take measurement by lowering unit to target window on sample and holding.

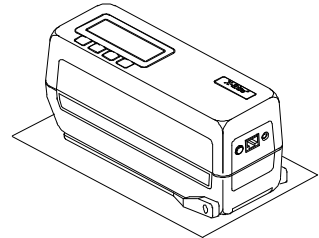

- “READING COMPLETE”, “Measurement Data” and “Pass/Fail” indication is displayed with instrument held down.

☞ "Pass/Fail" indication will only display if the pass/fail storage option is activated (see previous page).

- Release instrument from sample.

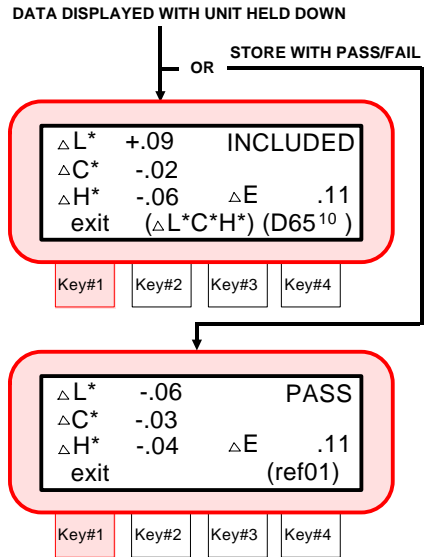

- 6) The last measurement data can be redisplayed by pressing **[view]** key #2.

☞ Measurements can be taken in the view mode if desired.

The “data group name” can be customized by “downloading” group names with QA-Master software package.

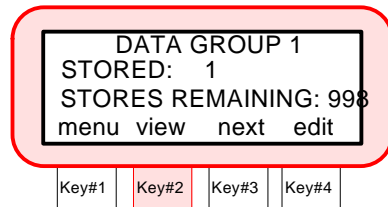

6.2 Deleting Stored Measurements

There are three methods for deleting stored measurements.

- ❑ **Delete Last** - Allows only the last measurement taken in the selected group to be deleted from stored memory.
- ❑ **Delete Group** - Deletes all stored measurements in the selected group.
- ❑ **Delete All** - Causes all stored measurements in all twenty groups to be deleted.

To delete a measurement:

- 1) At Storage Menu level, press **[edit]** key #4 to enter “**SELECT EDIT OPTION**” menu.

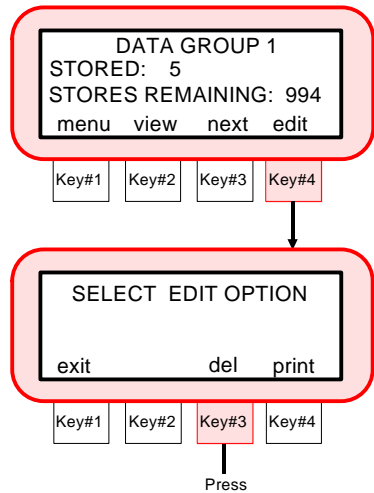

- 2) Press the **[del]** key #3 to enter the “**SELECT DELETE MODE**” menu.

☞ If auto reference is disabled key #2 will allow selection and editing of reference tolerances.

Delete Last

- 3) Press **[last]** key #4.

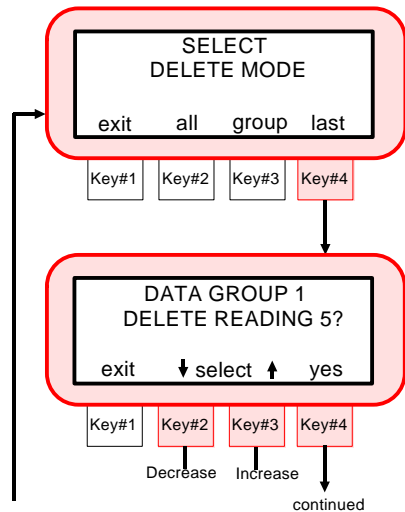

- 4) Press **[↓]** key #2 or **[↑]** key #3 to select desired group number.

- Press **[yes]** key #4 to delete last measurement in the selected group.



- 5) Press **[exit]** key #1 to return to the delete mode menu.

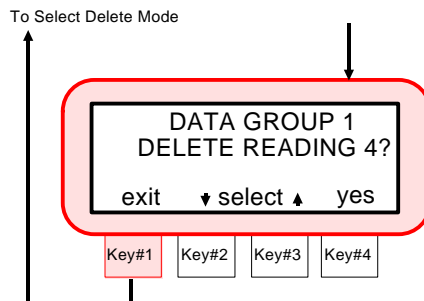

Delete Group

- 3) Press **[group]** key #3.

- 4) Press [↓] key #2 or [↑] key #3 to select desired group number.

- Press **[yes]** key #4 to delete selected group.

- **"DATA GROUP # DELETED"** is displayed.

- 5) Press **[exit]** key #1 to return to the delete mode menu.

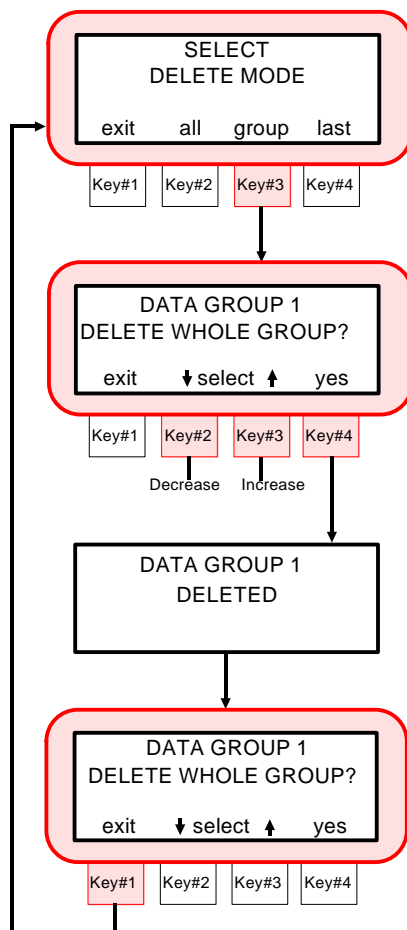

Delete All

3) Press **[all]** key #2.

4) Press **[yes]** key #4 to clear all stored data in all groups.

- “**ALL DATA CLEARED**” is displayed.

5) “**RESET GROUPS TO DEFAULTS?**” is displayed.

- Press **[no]** key #1 to keep preset group names (i.e., names set in QA-Master). Press **[yes]** key #4 to reset names to factory defaults (i.e., Data Group 1, etc.).

6) Press **[exit]** key #1 to exit delete mode.

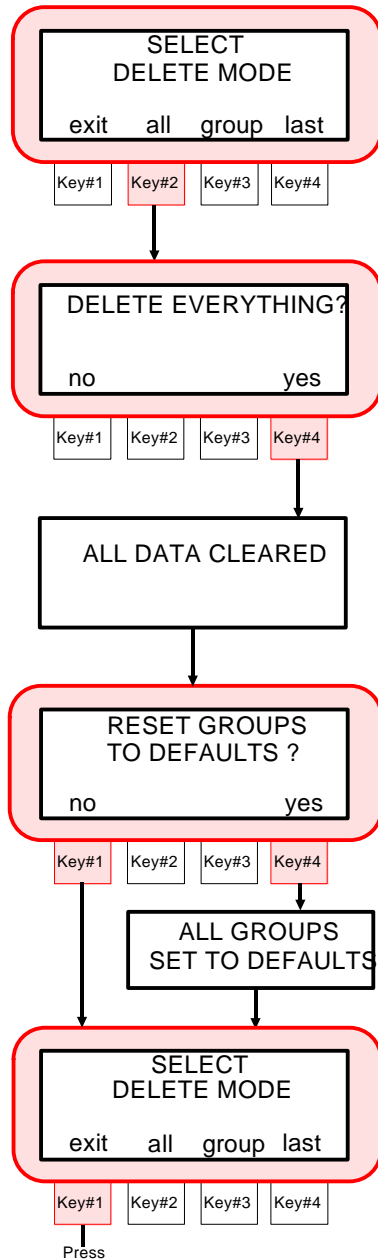

6.3 Printing Stored Measurements

The SP68 has the ability to output stored measurement data directly to a serial printer or a computer. The format that data gets printed in is controlled by the Printout Options select in Section 7.3.

The measurement data that is printed depends on what Storage Option is selected in Operation Options (Section 7.2).

To print stored measurements:

- 1) Refer to Section 7 to set RS-232 and Printout Options, if required.

- 2) In storage mode, press **[edit]** key #4 to enter “**SELECT EDIT OPTION**” screen.

- 3) Press **[print]** key #3 to enter “**SELECT PRINT MODE**” screen.

There are three modes of print that can be accessed during stored data printout.

- Print Last** - will print the data of the last measurement taken in the selected group.
- Print Group** - will print all measurements that are currently in the selected group. The group printout function will also printout the "Group #" for each group that has data.
- Print All** - all measurements that are stored will be printed.

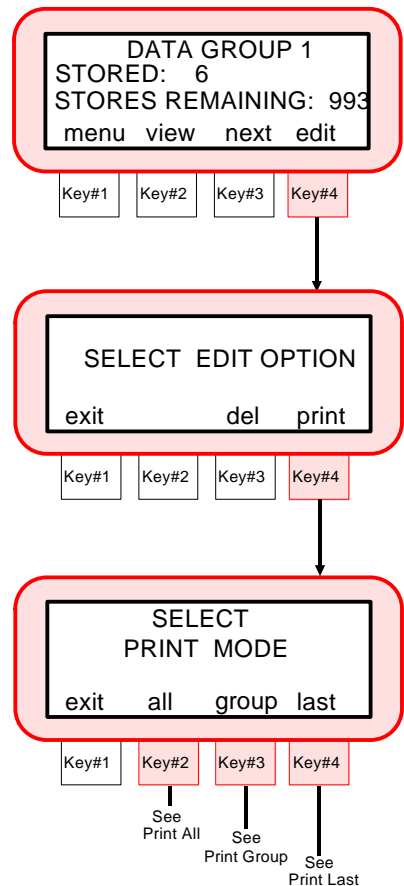

Print Last

4) Press [**last**] key #4 to enter print last mode.

5) Press the [↓] key #2 or [↑] key #3 to select desired group.
- Press [**yes**] key #4 to print last measurement in the selected group.

6) “**PRINTING DATA**” is displayed and then the display returns to “**DATA GROUP**” menu.
- Press [**quit**] key #1 to stop printing.

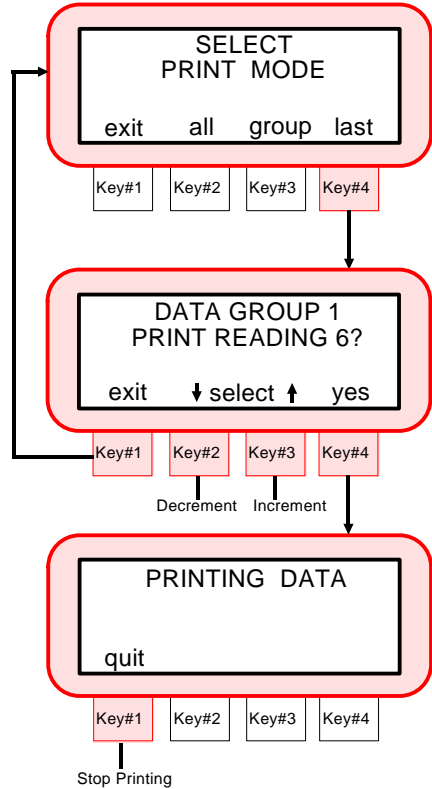

Print Group

4) Press **[group]** key #3 to enter print group mode.

5) Press [↓] key #2 or [↑] key #3 to select desired group.

- Press **[yes]** key #4 to print all measurement data in the selected group.

☞ If [↑] key #3 is depressed one more time after "DATA GROUP 20" is displayed, "PRINT ALL GROUPS ?" will display. Selecting this option will printout all groups with existing measurement data.

6) "PRINTING DATA # OF #" is displayed until all data is printed, then the display will return to **DATA GROUP** menu.

- Press **[quit]** key #1 at anytime to abort printing operation.

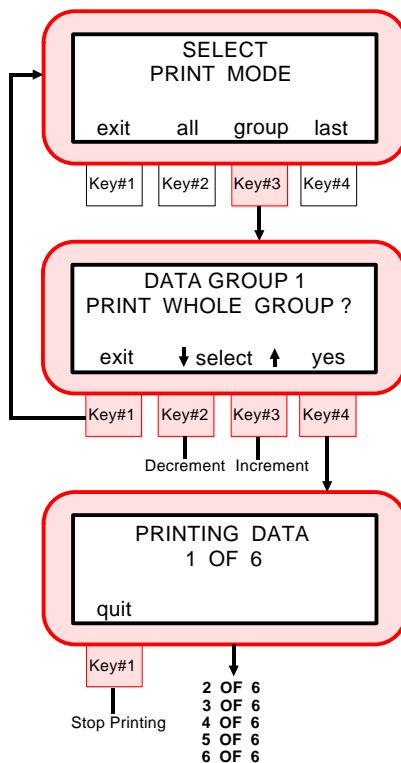

Print All

4) Press **[all]** key #2.

5) "PRINTING DATA # OF #" is displayed until all data is printed, then the display will return to "SELECT PRINT MODE" menu.

- Press the **[quit]** key #1 at anytime to abort printing operation.

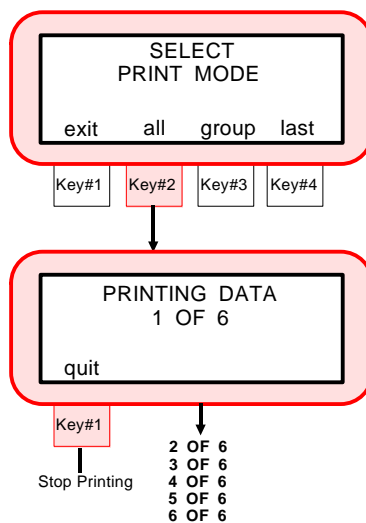

6.4 Tagging and Storing Operation (with optional BCR) —————

☞ Tags are entered by scanning. If you intend to use the optional Bar Code Reader (BCR), we suggest that you read Section 9 before continuing with this tagging operation.

Tags are used as a method to label stored measurement samples for identification. The sample data can then be printed or uploaded to X-Rite's QA-Master® with tags applied.

Individual measurements can have from 1 to 6 tags attached. There are three tag options to select from once a tag is scanned.

Tag All - This option will only appear on the instruments display when no measurement data is stored in the instrument. Any measurement that is taken after “all” is selected will have the scanned tag attached.

Tag Group - This option will only appear on the instruments display when a new group is selected that has no stored measurements. Any measurement taken in that group after “group” is selected will have the scanned tag attached. The first tag that is scanned under group will also be used as the group name on the instrument.

Tag Next - This option will store the scanned tag with the next sample that is measured.

When the stored measurement data from the instrument is uploaded to X-Rite's QA-Master software program, all tags that were attached will also transfer.

To tag and store a measurement:

- 1) Press [store] key #4 at the “MENU PAGE 1” level to enter storage function.

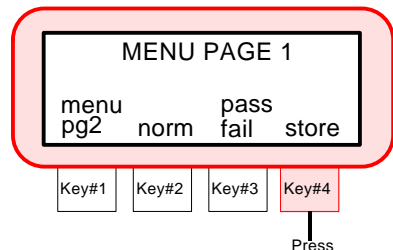

☞ If “STORE WITH PASS/FAIL” and “AUTO REFERENCE DISABLED” are selected in Operation Options (Section 7.2), continue with Step 2. If Auto Reference is Enabled, advance to Step 3.

2) Press **[edit]** key #4 to enter
 “SELECT EDIT OPTION” screen.

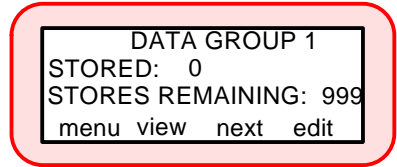

- Press **[ref #]** key #2 to enter
 “TOLERANCE MODE” screen.

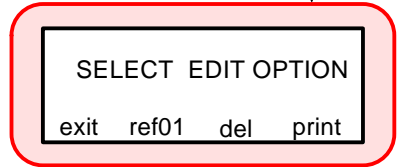

- Select desired reference for
 pass/fail indication. Press [↓] key
 #2 to decrement and [↑] key #4
 increment through reference #'s.

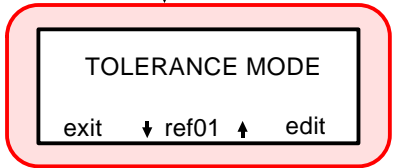

- Press **[exit]** key to return to “DATA
 GROUP #” screen.

3) Select desired data group number
 (or name downloaded from
 QA-Master) by repeatedly pressing
 the **[next]** key #3.

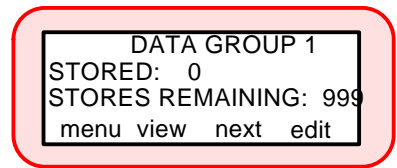

- 4) Connect Bar Code Reader to I/O port if not already connected, and scan the desired bar code. Refer to Section 9 to attach or if scan did not work correctly.



- 5) The bar code name should appear on the first line of the display.
 - Select desired tagging method.

- Press **[tag all]** key #2 if every measurement that is to be stored will receive the scanned tag.

☞ **“tag all”** will not appear if any measurements have previously been stored.

- Press **[tag group]** key #3 if all measurements in the selected group will have the same scanned tag.

☞ If a group is not named and **“tag group”** is selected, the scanned tag name will take the place of the data group # on the first line of the instrument display.

“tag group” will not appear if any measurements have previously been stored in the group.

- Press **[tag next]** key #4 if the measurement to follow will be the only sample with the scanned tag attached.

- A total of “6” tags can be attached to each measurement. The total of “6” tags includes combinations of “all”, “group”, and “next” tag selections.

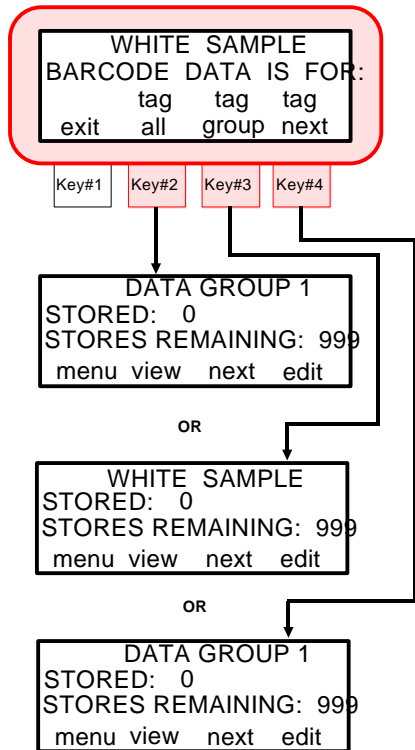

- 6) Scan additional bar codes if more are required for “all”, “group”, or “next” samples.

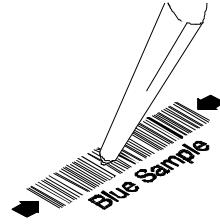

- ☞ If no tag method is selected before a measurement is taken, the instrument assumes a “next tag” selection.

- 7) Take measurement by lowering the unit to the target window on the sample.

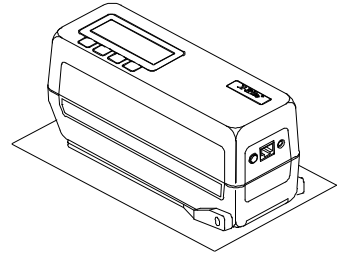

- Lift unit off sample after “READING COMPLETE” indication is displayed.

- ☞ “Pass/Fail” indication will only display if the pass/fail storage option is activated

- 8) The measurement data can be displayed by pressing [view] key #2.

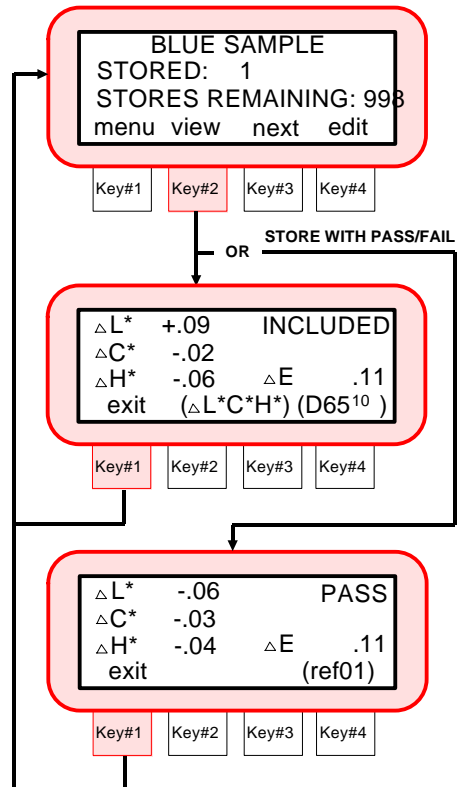

- 9) Press the [exit] key #1 to return to the storage display.

- 10) Continue with additional tag storage measurements if required.

QA-Master Group Name Special Feature

The SP68 has a unique feature that allows the user to automatically switch to a “group” that uses the same name as the scanned tag.

For example, if “GROUP #5” is named “Light Blue #6” and the scanned tag has the same name, the SP68 will display a **[group]** key. Pressing this key allows you to switch to that group if desired.

The **[tag]** key that displays works in the same manner as “next tag.” Pressing this key will store the scanned tag with the originally selected group.

The **[group]** key will only appear if tags that are scanned have the same names as downloaded “group names.”

QA-Master Sample Tagging Special Feature

Remotely measured samples can be assigned with Accept/Reject status using the BCR tagging option. Uploaded samples in QA-Master can be given the desired Accept/Reject status.

Notes:

- To assign a sample with Accept/Reject status, a tag must be scanned with the desired status name before the measurement is taken.
- The sample status **ACCEPT**, **REJECT**, or **UNDETERMINED** must be scanned in as capital letters.
- If a sample is assigned both “**ACCEPT**” and “**REJECT**” status, the sample will be uploaded as “**UNDETERMINED**.”

6.5 QA-Master “Run Job” Operation ---

The “Run Job” function is used to activate a series of tagging and storing operations that can be programmed in the unit by X-Rite’s QA-Master software package. A typical “job” would allow multiple information tags to be applied to each stored measurement. See the QA-Master Users Manual for further information.

A [run job] key will appear on “MENU PAGE 2” of the instrument display once a job is downloaded. This key is used to activate a job.

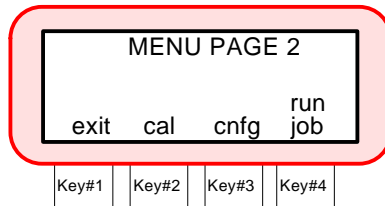

SECTION 7

SETTING SYSTEM CONFIGURATION

Subjects covered in Section 7 are:

- 7.1 Setting RS-232 Communication Options
- 7.2 Setting Operation Options
- 7.3 Setting Printout Options
- 7.4 Setting Date and Time

The system configuration allows you to customize the instrument to meet your application requirements. The configuration should be set before any measurements are taken.

7.1 Setting RS-232 Communication Options ---

The SP68 comes equipped with a serial port that allows data to be transmitted/received to/from an external device. Listed below are available I/O options.

Communication Emulation - allows the SP68 to emulate other instrument outputs. When set to OFF, the instrument communicates normally. When set to ON, alternate communication modes can be selected from a list of options. Specific details on this feature can be obtained from your X-Rite representative. The factory default is "OFF." Specific details on this feature are contained in publication SP68-602: "Sphere Spectrophotometer Instrument Emulation", available from your X-Rite representative.

Baud Rate - determines the input/output rate (characters per second) of the RS-232 port. Available outputs are: 300, 600, 1200, 2400, 4800, 9600, and 19200. The factory default setting is "9600" baud.

Line Feed Operation - varies the delimiter at the end of each line of data. When set to OFF, just a carriage return is sent at the end of a line of data. When set to ON, a carriage return then a line feed are sent at the end of the line of data. The factory default setting is "LF with CR."



Handshake Operation - is used for data transmission. Handshake may be set to NO HANDSHAKE, PIN 5 is CTS SIGNAL, Pin 5 is BUSY SIGNAL, or XON/XOFF. Handshake should be set to “No Handshake” when not being used. The factory default setting is No Handshake.

To change the communication options:

- 1) Press **[menu]** key #1 twice to enter **MENU PAGE 2**.

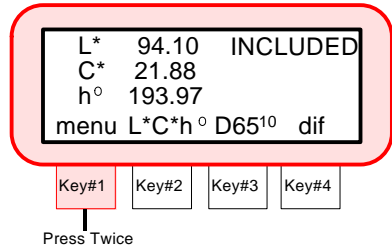

- 2) Press **[cnfg]** key #3 to enter configuration functions.

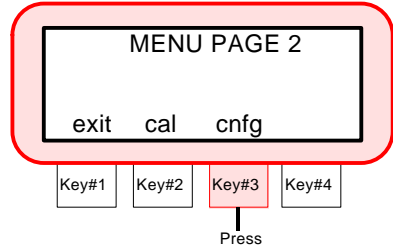

- 3) Press the [↓] key #3 or [↑] key #4 to select Communication Options, then press **[yes]** key #2.

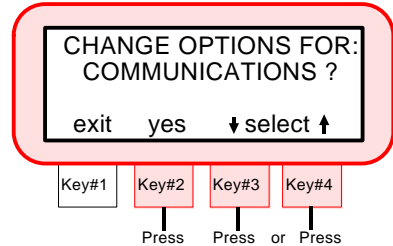

On certain options the [↓] key #2 will page down through the available settings, while the [↑] key #3 will page up through the available settings.

- 4) Set communication emulation to On or Off. Press [on] key #2 to set “EMULATION =ON”, or press [off] key #3 to set “EMULATION =OFF.”

If emulation is set to “ON”, contact your X-Rite representative for specific setup details.

- 5) Select the baud rate by pressing the [↓] key #2 or [↑] key #3. The available rates are: “300”, “600”, “1200”, “2400”, “4800”, “9600”, and “19200.”

- Press [next] key #4 to advance to next option.

- 6) Set the line feed option to On or Off. Press [on] key #2 to set line feed (on), or press [off] key #3 to set “no” line feed (off).

- Press [next] key #4 to advance to next option.

- 7) Select the handshake operation by pressing [↓] key #2 or [↑] key #3. The available options are: “NO HANDSHAKE”, “PIN 5 IS CTS SIGNAL”, “PIN 5 IS BUSY SIGNAL”, and “XON/XOFF.”

- Press the [exit] key #1 once to return to Communication Options main menu, or press key #1 twice to return to normal operation.

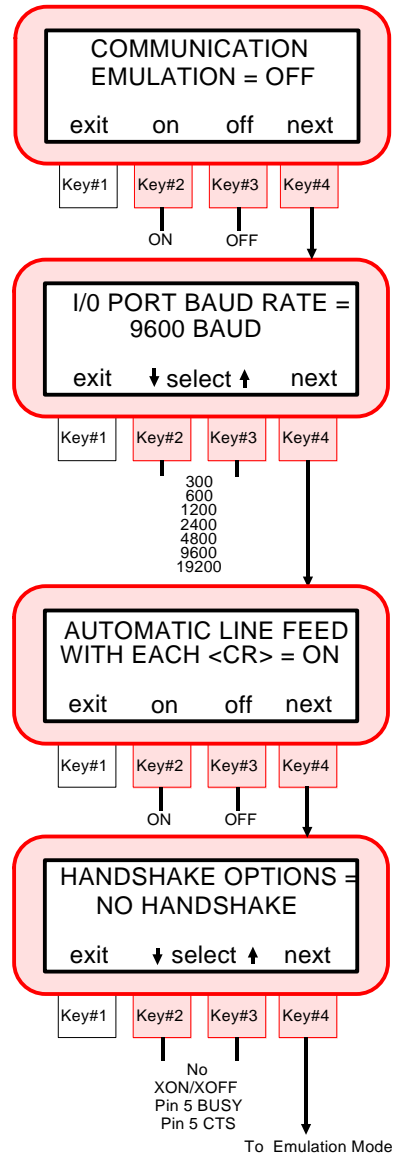

7.2 Setting Operation Options ---

There are nine options that can be adjusted to meet your requirements. Listed below is a description of these options and the procedure to change their settings.

Set Averaging - averaging mode is used to select “1-16” measurements for calculating a single sample reading. Measurements are taken at different locations on a sample to achieve average measurement values.

The average option can also be set to “auto averaging.” Auto averaging ensures accuracy when samples are very dark or high chroma.

Whenever an X, Y, or Z value of 2.5% or less is detected the instrument will automatically require three measurements. The three measurements will then be averaged into one value. “Auto Averaging” is set on at the factory and is the default setting.

☞ When averaging is set to “1”, no averaging is performed and no averaging measurements will be displayed.

Auto Reference - when set to “Enable”, the reference with the smallest color difference is automatically selected during a measurement. When set to “Disabled”, a reference must be selected before a measurement. Factory default setting is “Enabled.”

Reference Limit - allows you to select the number of references that can be available when selecting a reference location. The number of references can be set “1 - 50.” Factory default setting is “24.”

Color Space Options - individual color spaces may be turned Off or On depending on your requirements. This allows only the color spaces you need to display during operation. Factory default “on” settings are: “L*a*b*”, “LC*h°”, and “ΔEcmc.”

Select Illuminant/Observer - individual illuminant/observer pairs may be turned Off or On depending on your requirements. This allows only the illuminant/observers you use to display during operation. Factory default “on” settings are: “D65¹⁰”, “A¹⁰”, and “F2¹⁰.”

Storage Operation - allows you to select which type of data will be stored during storage operation. When set to “Store Data Only”, data from normal sample measurements will be stored in the instrument. When set to “Store with Pass/Fail”, data with pass/fail reference will be stored in the instrument. Factory default setting is “Store Data Only.”

Sphere Geometry - determines if displayed data has the specular component included or excluded. Factory default setting is "Included."

Delta Expression - When set to "Numbers", all $\Delta L^*a^*b^*$ and $\Delta L^*C^*H^*$ measurement will display deltas numerically. When set to "Words", all $L^*a^*b^*$ and $L^*C^*H^*$ difference measurement will display deltas as words (e.g., "brighter", "duller", ">>red", etc.).

When delta words are used, the "L*" attribute for $L^*a^*b^*$ or $L^*C^*H^*$ will display either "LIGHTER" or "DARKER" from the reference. The "a*" and "b*" attributes for $L^*a^*b^*$ and the "H*" (hue) attribute for $L^*C^*H^*$ will display as ">>RED", ">>GRN", ">>BLU", or ">>YEL." This is an indication of what color direction the difference is towards. For $L^*C^*H^*$, the "C*" (chroma) attribute will display as "BRIGHTER" or "DULLER." Factory default setting is "Numbers."

☞ No words will display for an attribute that is less than "1/7" of the Delta E value. A value less than this amount is considered insignificant compared to the total difference. If the delta value for any attribute is greater than 10.00, the display will change to numeric values.

Beeper Operation - determines the volume level that is output on the instruments beeper. Available settings are: "Soft" and "Loud."

To set the operation options:

- 1) Press [menu] key #1 twice to enter **MENU PAGE 2.**

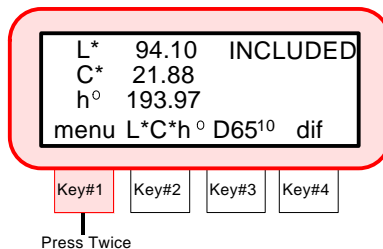

- 2) Press [cnfg] key #3 to enter configuration functions.

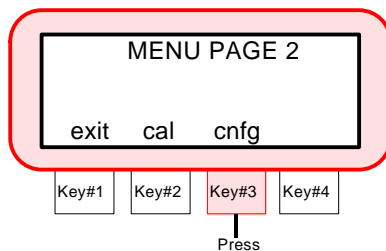

- 3) Press the [↓] key #3 or [↑] key #4 to select Operation Options, then press [yes] key #2.

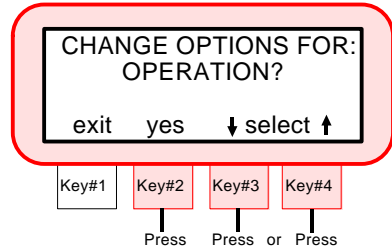

☛ On certain options the [↓] key #2 will page down through the available settings, while the [↑] key #3 will page up through the available settings.

- 4) Select the number of samples averaged (1 - 16) or Auto Averaging. Press [↓] key #2 to decrease and [↑] key #3 to increase averaging number

- Press [next] key #4 to advance to the next option.

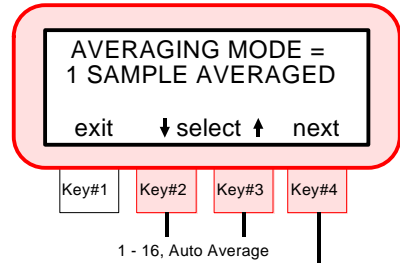

- 5) Select Auto Reference option. Press [on] key #2 to “ENABLE” or [off] key #3 to “DISABLE.”

- Press [next] key #4 to advance to the next option.

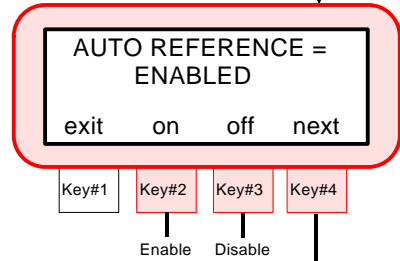

- 6) Select the number of reference locations required (1 - 50). Press the [↓] key #2 to decrement and the [↑] key #3 to increment.

- Press [next] key #4 to advance to the next option.

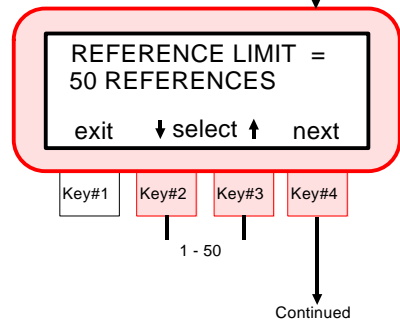

7) Select the color space you want to display.

- Press **[sel]** key #3 to select color space and press “**Key #2**” to turn color space Off or On. A color space turned Off will not display during normal operation.
- Press **[next]** key #4 to advance to the next option.

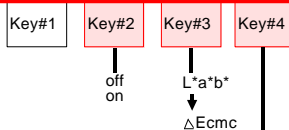
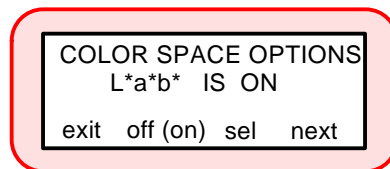

8) Select the illuminant/observer combinations you want to display.

- Press **[sel]** key #3 to select illuminant/observer and press “**Key #2**” to turn illuminant/observer Off or On. An illuminant/observer turned Off will not display during measurement sequence.
- Press **[next]** key #4 to advance to the next option.

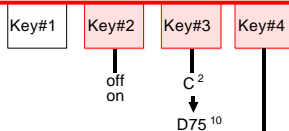
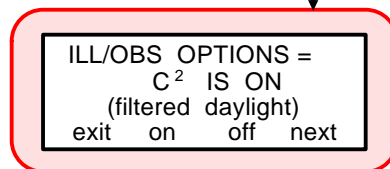

9) Select the storage operation by pressing the [↓] key #2 or [↑] key #3. The available settings are: “**STORE DATA ONLY**” and “**STORE WITH PASS/FAIL.**”

- Press **[next]** key #4 to advance to the next option.

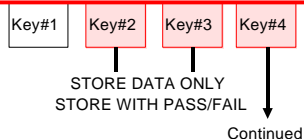
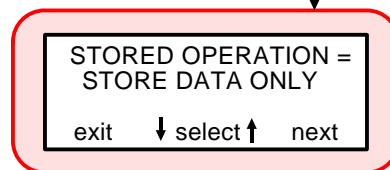

10) Select the sphere geometry by pressing the [↓] key #2 or [↑] key #3. The available settings are: “INCLUDED” and “EXCLUDED.”

- Press [next] key #4 to advance to the next option.
-

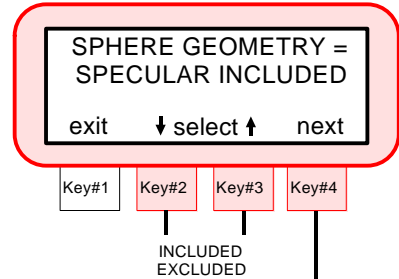

11) Select the delta expression by pressing the [↓] key #2 or [↑] key #3. The available settings are: “NUMBERS” and “WORDS.”

- Press [next] key #4 to advance to the next option.
-

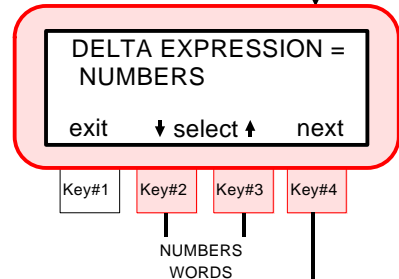

12) Select the beeper volume by pressing the [↓] key #2 or [↑] key #3. The available settings are: “SOFT” and “LOUD.”

- Press the [exit] key #1 once to return to Operation Options main menu, or press key #1 twice to return to normal operation.

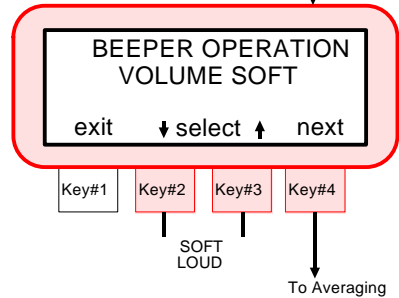

7.3 Setting Printout Options

Setting the printout options will determine what information will be transmitted out the RS-232 port after a measurement. Listed below are the available options that can be set.

Printout Format - determines if the measurement data is output in “Spectral Data” (400nm - 700nm in 10nm increments), or “Color Space Data” (L*a*b*, etc.). Factory default is “Color Space Data.”

Header Operation - enables or disables the header (L*a*b*, etc.) from printing during a data transmit. Factory default setting is “Disabled.”

Reference Operation - enables or disables the reference data from printing (if any) during a data transmit. Factory default setting is “Disabled.”

To set printout options:

- 1) Press **[menu]** key #1 twice to enter **MENU PAGE 2**.

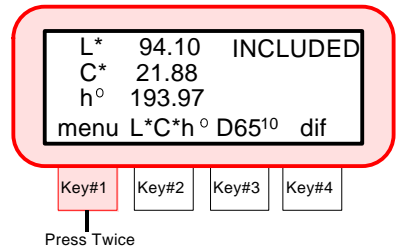

- 2) Press **[cnfg]** key #3 to enter configuration functions.

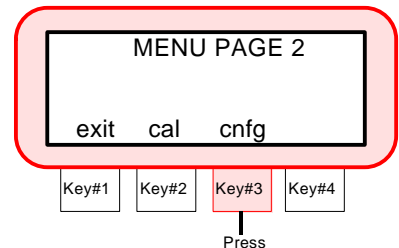

- 3) Press the [↓] key #3 or [↑] key #4 to select Printout Options, then press **[yes]** key #2.

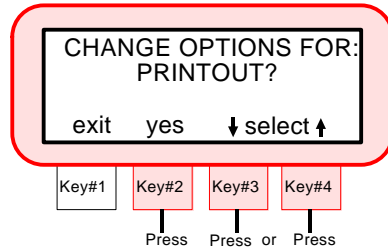

- 4) Select the printout format by pressing the [↓] key #2 or [↑] key #3. The available settings are: **“COLOR SPACE DATA”** or **“SPECTRAL DATA.”**

- Press **[next]** key #4 to advance to the next option.

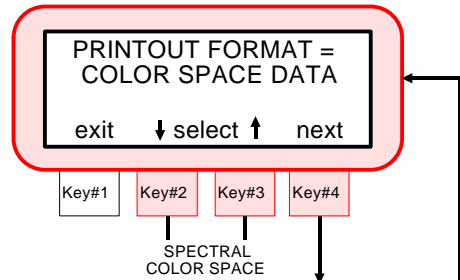

- 5) Set the header printout to Enabled or Disabled. Press **[on]** key #2 to print header (enabled), or press **[off]** key #3 to disable header print.

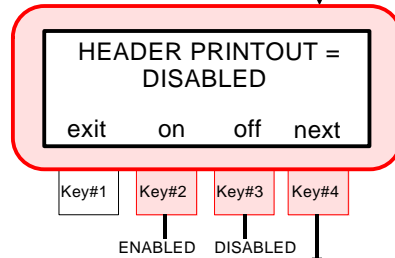

- 6) Set the reference printout to Enabled or Disabled. Press **[on]** key #2 to print reference (enabled), or press **[off]** key #3 to disable reference print.

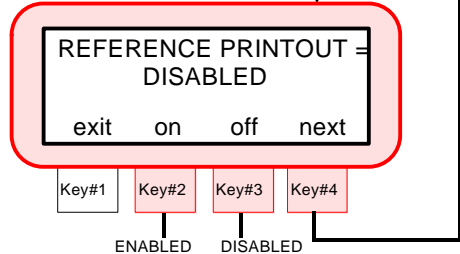

- Press the **[exit]** key #1 once to return to Printout Options main menu, or press key #1 twice to return to normal operation.



The following examples illustrate the different data output formats that can be obtained from the SP68 with a serial printer interfaced.

Example 1 - Color Space Format "ON"
Header "ON"
Reference "ON"

```
d(L*C*h) D65_10 INCLUDED 13:09:56 12-10-93
SP68 L -.18 C +.04 h .00 E .18
REF 01
SP68 L 70.76 C 4.83 h 79.12
```

Example 2 - Color Space Format "ON"
Header "OFF"
Reference "OFF"

```
L -.18 C +.04 h .00 E .18
```

Example 3 - Spectral Format "ON"
Header "ON"
Reference "OFF"

```
SPECTRAL DATA D65_10 INCLUDED 13:09:56 12-10-93
WAVELENGTH VALUE
400 60.81
410 47.25
420 38.77
430 36.51
440 37.05
450 37.09
460 37.39
470 37.49
480 37.71
490 38.28
500 39.02
510 40.73
520 41.26
530 41.73
540 42.38
550 43.02
560 43.58
570 43.92
580 43.81
590 43.40
600 42.56
610 41.84
620 41.61
630 42.17
640 43.87
650 46.87
660 51.89
670 57.57
680 62.64
690 67.52
700 67.89
```

7.4 Setting Date And Time

The date and time function allows you to adjust the instruments internal clock. Eastern Time Zone is the factory default setting.

The date and time will be printed (if "Header" is On) with each measurement when data is output to a printer. Refer below for setting procedure.

☞ If data is downloaded to the instrument from X-Rite's QA-Master software program, the instrument's clock will automatically be set to the computer's time and date.

To set the date and time:

- 1) Press **[menu]** key #1 twice to enter **MENU PAGE 2**.

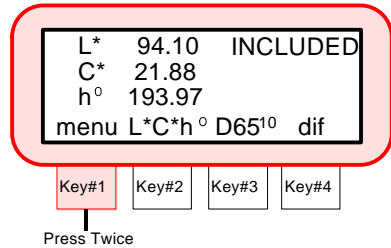

- 2) Press **[cnfg]** key #3 to enter configuration functions.

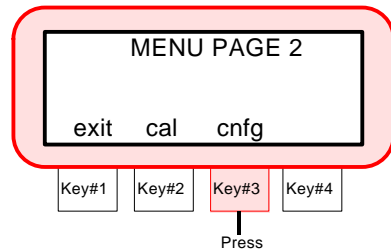

- 3) Press the **[↓]** key #3 or **[↑]** key #4 to select Date/Time Option, then press **[yes]** key #2.

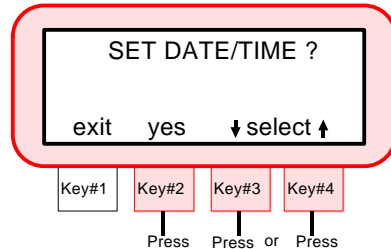

- 4) Set Date and Time.
 - Press **[next]** key #4 to move cursor to desired position on date or time.
 - Press **[+]** key #2 to increase.
 - Press **[-]** key #3 to decrease.
 - Press the **[exit]** key #1 once to return to Date/Time main menu, or press key #1 twice to return to normal operation.

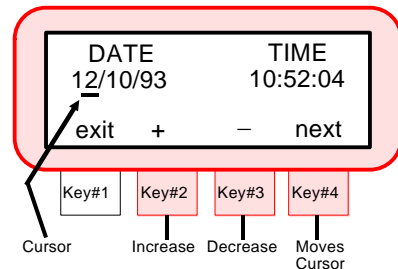

SECTION 8

GENERAL MAINTENANCE

Subjects covered in Section 8 are:

- 8.1 Cleaning the Instrument
- 8.2 Cleaning the Optics
- 8.3 Replacing the Battery Pack
- 8.4 Replacing the Target Window
- 8.5 Reading Lamp Replacement Information
- 8.6 Troubleshooting Tips

The X-Rite SP68 is covered by a one year limited warranty (excluding battery pack) and should be referred to the factory or authorized service center for repair within the warranty period. Attempts to make repairs within this time frame may void the warranty.

X-Rite provides a factory repair service to their customers. Because of the complexity of the circuitry all circuit repairs should be referred to the factory or an authorized service center.

X-Rite will repair any SP68 past warranty. Shipping costs to the factory or to an authorized service center shall be paid by the customer and the instrument shall be submitted in its original carton, as a complete unaltered unit.

8.1 Cleaning the Instrument

The exterior of the instrument may be wiped clean with a cloth dampened with water or a mild cleaner whenever required.

CAUTION: DO NOT use any ketone solvents to clean the unit. This will cause damage to the cover.

8.2 Cleaning the Optics

The optics should be cleaned once a week in normal environments, and more often in dirty or dusty environments.

1. **Unplug the AC adaptor and turn the power switch Off.**
2. Carefully lift the instrument up and blow short bursts of clean, dry air into the optics opening. This should remove any accumulated dust in the optics area.

WARNING:

Do not invert air cans that use freon as a propellant. Doing so could cause damage to the optics assembly.

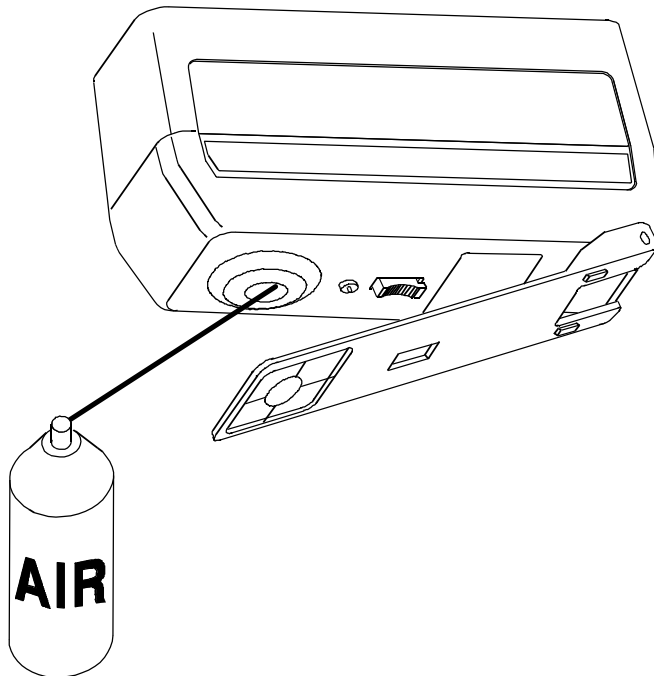

8.3 Replacing The Battery Pack

1. Unplug the AC adaptor and turn the power switch Off.
2. Carefully place the instrument on it's top and lock the shoe next to instrument.
3. Remove battery access cover by sliding towards rear of unit.
4. Grasp plastic tab that extends from battery pack and pull until pack is removed.
5. Slide new (or charged) battery pack into instrument until connector is properly seated.
6. Reinstall battery access cover by sliding into position.
7. Discharged battery packs should be charged in the instrument for 16 hours.

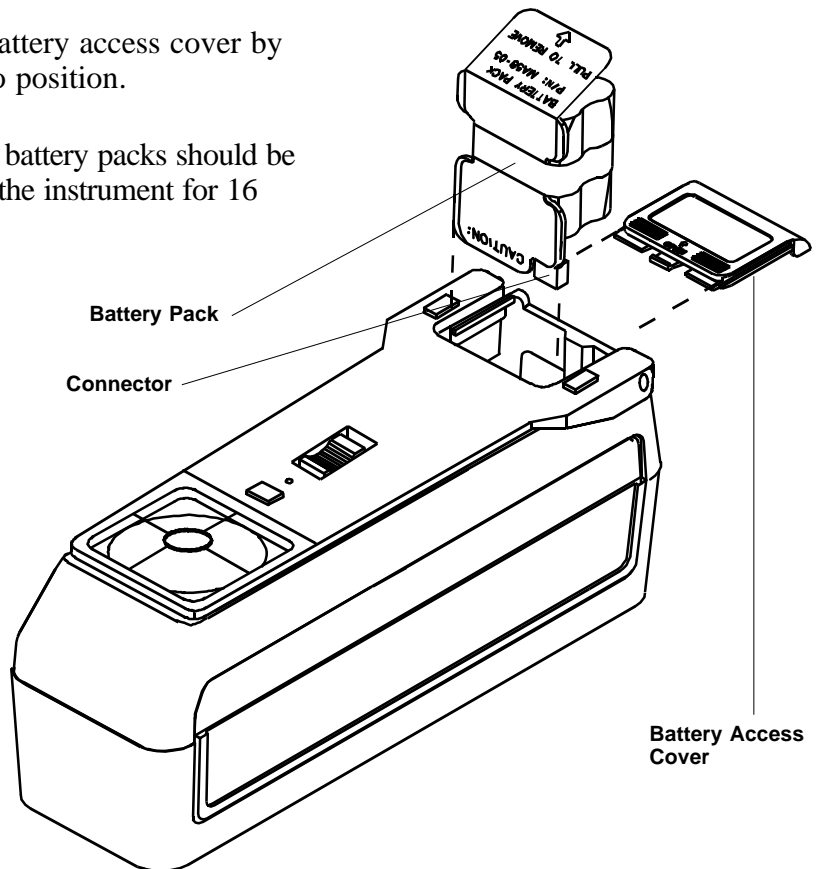

8.4 Replacing the Target Window

Refer to Figure 1

1. Unplug the AC adaptor and turn the power switch Off.
2. Carefully place instrument on end and remove old target window [1] by pushing outward from inside of shoe [2]. Clean off any remaining adhesive from shoe [2].
3. Insert target window alignment plug [3] into sensor nose [4].

Refer to Figure 2

4. Compress shoe [2] all the way down and lock in position.
5. Remove paper backing [5] from adhesive on new target window [1].
6. Place target window hole over alignment plug [3] and align crosshairs [6] squarely with shoe [2].
7. Remove clear protective backing [7] from target window [1].
8. Unlock shoe [2] and remove alignment plug [3].

Fig 1

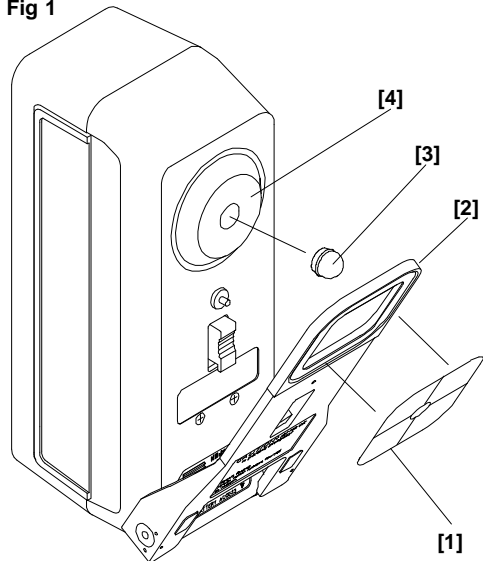
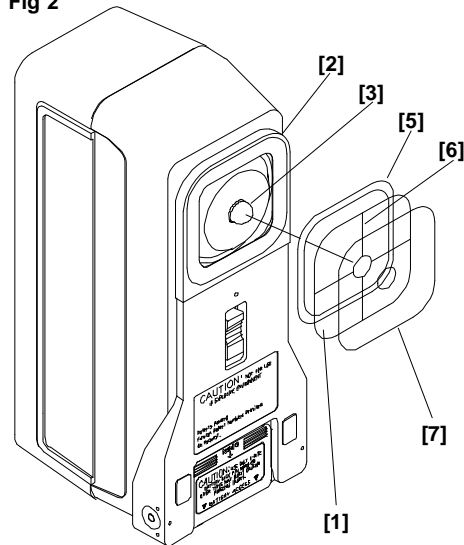

Fig 2



Replacement Target Windows: SP68-21-04 (Small) SP68-21-08 (Standard) SP68-21-14 (Large)

8.5 Reading Lamp Replacement Information ---

Due to the circuit complexity, critical alignment procedures, and test equipment required - **The read lamp should only be replaced by X-Rite or an authorized X-Rite Service Center.**

The lamp is monitored for intensity, and failure warnings will be displayed if a problem occurs.

The lamp should last approximately 500,000 measurements and is covered by a one year limited warranty. Refer to the Limited Warranty statement on page iii.

8.6 Troubleshooting Tips ---

Instrument will not turn On (on display):

- Power switch off (battery operation only).
- Batteries are very low and in need of charge.
- Contact X-Rite or Authorized Service Center.

Instrument will display but not measure:

- Battery pack not installed.
- Contact X-Rite or Authorized Service Center.

Incorrect measurement data continually displays:

- Check standard material.
- Calibrate instrument (see Sec. 3).
- Clean optics (see Sec. 8).
- Contact X-Rite or Authorized Service Center.

Measurement drifts:

- Clean optics (see Sec. 8).
- Calibrate instrument (see Sec. 3).
- Contact X-Rite or Authorized Service Center.

Instrument will not calibrate properly:

- Calibration standard needs to be cleaned (see Sec. 3).
- Clean optics (see Sec. 8).
- Contact X-Rite or Authorized Service Center.

SECTION 9

BAR CODE READER (optional)

Subjects covered in Section 9 are:

- 9.1 Attaching SP78-200 Bar Code Reader to an Instrument
- 9.2 Scanning a Bar Code
- 9.3 Troubleshooting

The Optional SP78-200 Bar Code Reader is used to scan bar codes. When the BCR is used in conjunction with an X-Rite instrument, a scanned bar code becomes a tag for the measurement(s) taken with the instrument. When the data is uploaded into a software program (e.g., QA-Master®) the bar code tag(s) become sample tag(s).

9.1 Attaching The SP78-200 BCR to the Instrument _____

Attach the BCR to the instrument's I/O Port. The instrument must be operating in the Storage mode before the BCR will operate.

To attach the SP78-200 BCR:

- 1) Insert the connector on the BCR into the I/O port of the instrument until it locks, usually indicated by an audible click. The connector inserts in one direction, (tab up) **DO NOT FORCE**. See Figure 1.
- 2) Power the instrument up, "**BAR CODE READER DETECTED**" will appear on the instrument display if the BCR is properly attached.

To disconnect the SP78-200 BCR:

- 1) Depress the tab on the connector and remove the connector from the instrument.

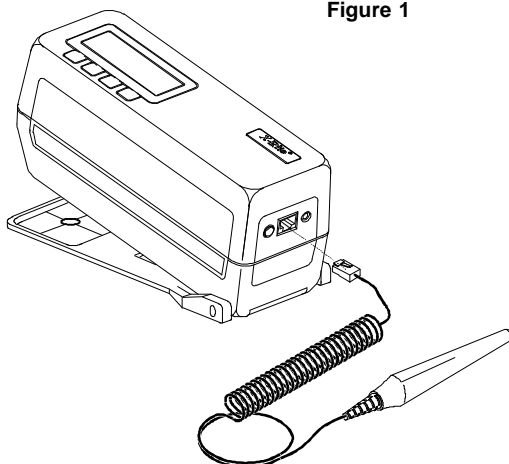

Figure 1

9.2 Scanning a Bar Code

Follow these guidelines for successful bar code scanning.

- 1) Turn on the X-Rite instrument. Be sure the instrument is in the Storage mode.
- 2) Hold the BCR in your hand as you would a pencil. The BCR works best when tilted from 10° to 30°, although any angle from 5° to 45° will work. See Figure 2.

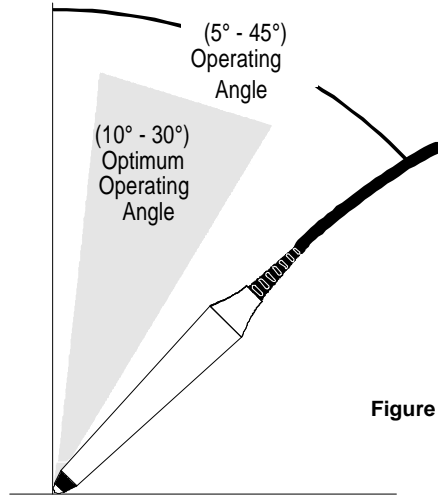

Figure 2

- 3) Place the tip of the BCR on the white space to the left or right of the bar code. Drag the BCR smoothly and lightly across the bar code. Do not lift the tip of the BCR from the surface of the bar code. See Figure 3.
- 4) The instrument will display the title of the bar code if the scan was successful. If the display appears blank try scanning the bar code again. If after several scanning attempts the display still appears blank, see Section 9.3, Troubleshooting.

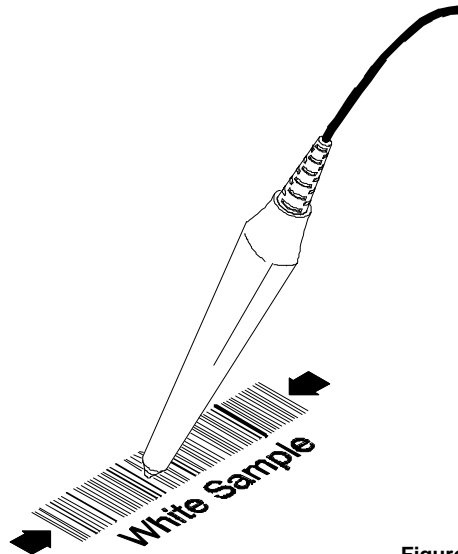

Figure 3

9.3 Troubleshooting

The factory default mode can be restored if the SP78-200 BCR is placed into an unusable or unknown configuration.

To restore the factory default mode:

- 1) Disconnect the BCR from the instrument.
- 2) Reconnect the BCR to the instrument.
- 3) Scan the default configuration bar codes shown on the SP78-200 Bar Code Reader instruction sheet (P/N SP78-510).

Does the SP78-200 BCR have power?

- A red light will be visible at the tip of the BCR if it has power.
- Check the connection between the BCR and the instrument. Be sure the connector is correctly inserted.
- Check the power supply for the instrument. Refer to the instrument User's Manual, Troubleshooting section if the instrument does not have power.

Is the SP78-200 BCR configuration correct?

To restore the factory default mode:

- 1) Disconnect the BCR from the instrument.
- 2) Reconnect the BCR to the instrument.
- 3) Scan the default configuration bar codes.

Does the SP78-200 BCR wavelength of light match the bar code?

The BCR will not read bar codes that are designed to be secure (black on black.) The optical signal returning from the bar code is not adequate for measuring the bars and spaces.

Is the SP78-200 BCR being held at the correct angle?

The BCR will operate when held at an angle of 5° to 45°. The optimum operating angle is from 10° to 30°.

Was the entire bar code scanned?

- Drag the BCR through the entire bar code at a constant speed. Increase the scanning speed. Typically the BCR is moved too slowly.
- Be sure the BCR scans the entire bar code.
- Be sure the BCR maintained contact with the surface of the bar code.
- Be sure the bar code is not damaged, dirty or worn. Try to scan an area without these defects.

Does the SP78-200 BCR tip need replacement?

If the tip becomes damaged or shows signs of excessive wear, it must be replaced.

To replace the tip:

- 1) Disconnect the BCR from the instrument.
- 2) Unscrew the tip from the wand.
- 3) Replace using part number SE124-01-01.

APPENDIX - A

TECHNICAL SPECIFICATIONS

Measuring Geometries:

d/8°

Fiber optic pick-up with multi-sensor array

SP68S - Small Area View (6mm illumination / 4mm viewing)

SP68 - Standard Area View (11mm illumination / 8mm viewing)

SP68L - Large Area View (18mm illumination / 16mm viewing)

SP68T - (18mm illumination / 8mm viewing)

NOTE: Illumination area is minimum specimen size.

Light Source:

Gas-filled tungsten lamp, approx. 3000°K

Illuminant Types:

C, D65, D50, A, F2, F7, F11, F12 & D75

Standard Observers:

2° & 10°

Measurement Functions:

Pass/Fail based on: $L^*a^*b^*$, $L^*C^*h^°$, XYZ, Y_{xy} , Lab (Hunter), Whiteness per CIE and ASTM E313, & Yellowness per ASTM E313 and D1925, $\Delta L^*a^*b^*$, $\Delta L^*C^*H^*$, ΔXYZ , ΔY_{xy} , ΔLab (Hunter), ΔWht , ΔYel , ΔE^* , & ΔE_{cmc}

Receiver:

Blue-enhanced silicon photodiodes

Spectral Range:

400nm - 700nm

Spectral Interval:

20nm - measured (15nm bandwidth)

10nm - output

Storage:

50 References

999 Samples

Measurement Range:

0% - 200% Reflectance

Measuring Time:

Approx. 2.5 seconds

Inter-instrument Agreement:*

0.20 ΔE^*_{ab} based on average of 12 BCRA series II tile

0.40 ΔE^*_{ab} max on any tile

Short Term Repeatability:

0.05 ΔE^*_{ab} max (SP68, SP68L)

0.10 ΔE^*_{ab} max (SP68S)

20 measurements on white calibration reference at 5 second intervals.

Lamp Life:

Approx. 500,000 measurements

Power Supply:

Six rechargeable AA Ni-metal hydride batteries included - Removable battery pack 7.2VDC rated @ 1100mAh

AC Adaptor Requirements:

SP68: 90-130VAC, 50-60Hz, 18W Max

SP68X: 180-260VAC, 50-60Hz, 20W Max

12VDC @ 700ma: Positive Tip

* Specular component included with similar measurement area.



Charge Time:

In Instrument - 4 hours (50%),
16 hours (100%)

External Pack - Approx. 16 hours

Measurements per charge:

500 measurements

Data Interface:

Patented bi-directional RS-232,
300 - 19200 baud

Display:

4-row by 20 character supertwist
dot matrix LCD

**Operating Temperature
Range:**

10°C to 40°C (50°F to 104°F)
85% relative humidity maximum
(non-condensing)

CAUTION: This instrument is
not for use in explosive
environments.

Storage Temperature Range:

-20°C to 50°C (-4°F to 122°F)

Weight:

1.4 kg (3 lbs. 2oz.)

Dimensions:

Height - 11.6 cm (4.56 in)

Width - 7.62 cm (3.0 in)

Length - 22.5 cm (8.85 in)

Accessories:

Carrying Case, Calibration Standard,
Black Trap, Users Manual and AC
Adaptor

APPENDIX - B

DISPLAY MESSAGES

The most likely reasons for error messages to display are described below. If an error message is consistently displayed, contact X-Rite or an Authorized Service Center.

Measurement Error Messages

- “**INVALID READING - BATTERIES VERY LOW, MUST BE CHARGED** ” - indicates batteries are too low to operate the unit. Plug in charger and wait 5 minutes before attempting to take accurate measurements.
- “**INVALID READING - LIGHT LEAKAGE** ” - stray light is getting into measurement aperture. Make sure measurement surface is flat.
- “**INVALID READING - MAXIMUM REFLECTANCE EXCEEDED** ” - surface measured is greater than the maximum range of the instrument (200%).
- “**INVALID READING - RESET DURING READ, CHECK BATTERIES** ” - this message may appear if the instrument is stored for an extended period of time. Recharge the batteries for 16 hours. If batteries are not charged after 16 hours, replace battery pack.
- “**INVALID READING - SWITCH RELEASED TOO SOON** ” - read switch was not closed during entire reading. Try taking reading again.

Calibration Error Messages

- “**CALIBRATION ERROR #####** ” - calibration requires that the instrument remains motionless during the white cal. If the error persists and is not due to movement, the number that is displayed should be reported to X-Rite or an authorized service center.
- “**NEED CALIBRATION - DUE TO ABORTED CAL, READ WHITE** ” - the user aborted the calibration procedure during measurement sequence.
- “**NEED CALIBRATION - DUE TO BAD ZERO CAL** ” - zero reflectance calibration measurement was not properly updated.



Calibration Error Messages - continued

“NEED CALIBRATION - DUE TO TEMPERATURE, READ WHITE ” - a 10°C change in temperature occurred since the last calibration.

“NEED CALIBRATION - DUE TO 4 HOUR FLAG, READ WHITE ” - a calibration procedure has not been performed for 4 hours.

“WARNING! - LARGE CHANGE, CHECK FOR DUST ” - indicates excessive dust was detected in the optics or black trap, or internal drift of components occurred during a zero calibration. If this message does occur, check for dust in the optics or black trap. If not dust is present, the message may indicate normal instrument drift.

Miscellaneous Error Messages

“BAD CODE RECEIVED - NOT IN STORE MODE ” - Indicates that a bar code was scanned when the instrument was not in storage mode.

“BATTERY LOW” - indicates that the batteries are getting low and will soon need to be charged. It will only be displayed while the measurement is in progress. The instrument will still take accurate measurements.

“LAMP FAILURE - LAMP MUST BE REPLACED ” - the lamp intensity is too weak for accurate measurements. The lamp should only be replaced by X-Rite or an authorized service center.

“LAMP WARNING - REPLACE LAMP SOON ” - the lamp is marginal and should be replaced as soon as is conveniently possible.

APPENDIX - C

OPTIONAL ACCESSORIES

- QA-Master® Software Package 1255-00
- Battery Pack Assembly.....MA58-05
- SP78-200 Bar Code Reader.....SP78-200
- Portable Thermal Printer (115VAC) 418-113
- Portable Thermal Printer (230VAC)418X-113
- Wrist StrapSP68-112
- Interconnect cable for Macintosh® computers
with 8 pin mini-DIN connector 418-79
- Modular Interconnect Cable (requires adaptor below)SE108-69
- DB25P DCE (Null Modem) Interface Adaptor 418-70
- DB25S DCE (Null Modem) Interface Adaptor 418-71
- DB25P DTE (Normal) Interface Adaptor 418-80
- DB25S DTE (Normal) Interface Adaptor 418-81
- DB9P Interface Adaptor 418-90
- DB9S Interface Adaptor 418-91

- Spectrophotometer Stand.....SP68-80

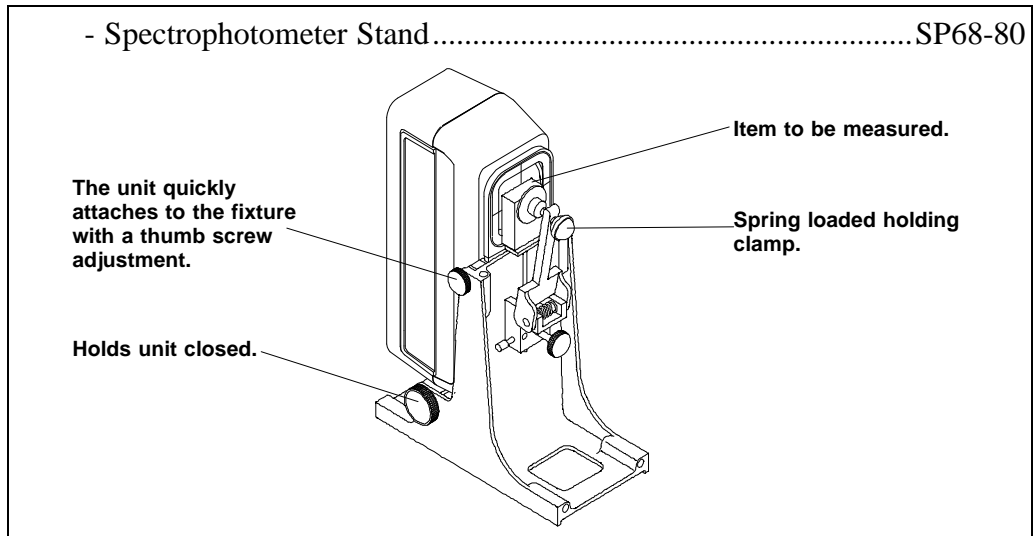

APPENDIX - D

COLOR CHECK

The color check procedure will help you track instrument color performance to assure measurement accuracy. Initially, the three patches on the standard should be measured once a day for a period of 10 days to determine the reference values. Thereafter, a periodic check (once a week depending on usage) is all that is required.

Located on the back of the reference standard envelope is a color check label. The reference data should be recorded there for quick reference.

Reference Data Procedure

To obtain reference values:

- 1) Clean instrument optics and reference standard if necessary.
- 2) Calibrate instrument according to procedure in operation manual. **Note:** The reference standard is dramatically affected by smudge marks and dust; and must be kept clean.
- 3) Select $L^*a^*b^*$ absolute function and desired illuminant/observer. **Note:** The selected illum/obs must be the same whenever the color check is performed.
- 4) Measure the White (1), Blue (2), and Brown (3) patches on the reference standard.

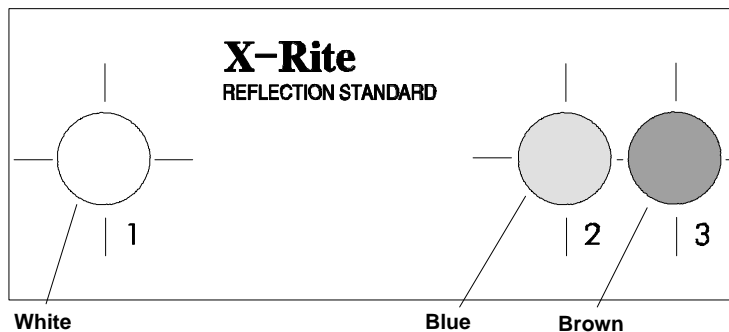

- 5) Record the $L^*a^*b^*$ values for each color on a piece of paper.
- 6) Repeat steps 1-5 for 10 days.



- 7) After 10 days average the white, blue, and brown values and enter data in the designated place on the color check label.

- 8) Enter date, illuminant, observer, aperture size, temperature, instrument model, and serial number on color check label. **Note:** Temperature of the reference standard should be maintained ($\pm 2^{\circ}\text{C}$) throughout color check sequence.

Periodic Color Check Procedure

- 1) Copy reference data located on the color check label to the shaded areas on the color check record located on the next page.

- 2) Perform steps 1-4 in reference data procedure.

- 3) Record the measured white, blue, and brown values and date on the color check record on the next page. **Note:** You may want to make several copies of the color check record before entering any data. This will allow you to have additional pages available when they are needed.

- 4) Compare measured values to the reference values.
 - If values are off, clean optics and reference standard and remeasure.
 - Consistent L^* , a^* , or b^* differences exceeding .30 (or obvious trends away from the reference data) may require the unit to be serviced. Contact X-Rite or authorized service center if this is the case.
 - Always verify color performance with the same aperture size, illum/obs, and temperature.



X-Rite, Incorporated—World Headquarters

3100 44th Street, S.W. • Grandville, Michigan 49418 • U.S.A.

www.x-rite.com

Tel: 1-888-826-3042 • Fax: 1-888-826-3043 or (616) 534-0067
International

Tel: 1-888-826-3039 or (616) 534-7663 • Fax: (616) 534-0723

X-Rite GmbH

Stollwerckstraße 32 • 51149 Köln • Germany

Tel: (49) 2203-91450 • Fax: (49) 2203-914519

X-Rite GmbH

Sochorova 705 • CZ-682 • 11 Vyskov • Czech Republic

Tel: (42) 0507-328197 • Fax: (42) 0507-328138

X-Rite Asia Pacific Ltd.

Room 808-10 • Kornhill Metro Tower • 1 Kornhill Road • Quarry Bay
Hong Kong • Tel: (852) 2-568-6283 • Fax: (852) 2-885-8610

X-Rite Ltd.

The Acumen Centre • First Avenue

Poynton, Cheshire • England

Tel: 9-011-44-0-1625-871100 • Fax: 9-011-44-0-1625-871444

X-Rite Méditerranée

Parc du moulin de Massy • 35, rue du Saule Trapu • 91300 Massy • France

Tel: 33-1-69.53.66.20 • Fax: 33-1-69.53.00.52

X-Rite Asia Pacific Limited - Japan Office

7F, IMAS Hamamatsu-cho Bldg. • 2-10-4, Hamamatsu-cho

Minato-ku, Tokyo • 105-0013 Japan

Tel: +81-3-5777-5488 • Fax: +81-3-5777-5489

X-Rite Asia Pacific Ltd. - Singapore Representative Office

14 Science Park Drive • #02-04 The Maxwell

Singapore Science Park • Singapore 118226

Tel: + 65 7788-773 • Fax: + 65 7788-645